

Canon

Multimedia Projector

LV-S2

Owner's Manual



E
English

TO THE OWNER

Before operating this projector, read this manual thoroughly to operate the projector properly.

This projector provides many convenient features and functions. Operating the projector properly enables you to manage those features and maintain it in better condition for a considerable time.

Improper operation may result in not only shortening the product-life, but also malfunctions, fire hazard, or other accidents.

If your projector seems to operate improperly, read this manual again, check operations and cable connections and try the solutions in the "TROUBLESHOOTING" section in the end at this manual. If the problem still persists, contact the sales dealer where you purchased the projector or the service center.



SAFETY PRECAUTIONS

WARNING : TO REDUCE THE RISK OF FIRE OR ELECTRIC SHOCK, DO NOT EXPOSE THIS APPLIANCE TO RAIN OR MOISTURE.

- This projector produces intense light from the projection lens. Do not stare directly into the lens as it could possibly damage your eyes. Be especially careful that children do not stare directly into the beam.
- This projector should be set in the way indicated. If not, it may result in a fire hazard.
- Take appropriate space on the top, sides and rear of the projector cabinet for allowing air circulation and cooling the projector. Minimum clearance must be maintained. If the projector is to be built into a compartment or similarly enclosed, the minimum distances must be maintained. Do not cover the ventilation slot on the projector. Heat build-up can reduce the service life of your projector, and can also be dangerous.
- Do not put any flammable objects or spray cans near the projector, hot air is exhausted from the ventilation holes.
- If the projector is not to be used for an extended time, unplug the projector from the power outlet.

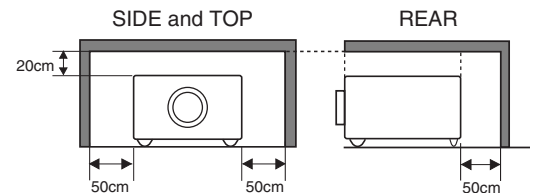

READ AND KEEP THIS OWNER'S MANUAL FOR LATER USE.



CAUTION
RISK OF ELECTRIC SHOCK
DO NOT OPEN



CAUTION : TO REDUCE THE RISK OF ELECTRIC SHOCK, DO NOT REMOVE COVER (OR BACK). NO USER-SERVICEABLE PARTS INSIDE EXCEPT LAMP REPLACEMENT. REFER SERVICING TO QUALIFIED SERVICE PERSONNEL.



THIS SYMBOL INDICATES THAT DANGEROUS VOLTAGE CONSTITUTING A RISK OF ELECTRIC SHOCK IS PRESENT WITHIN THIS UNIT.



THIS SYMBOL INDICATES THAT THERE ARE IMPORTANT OPERATING AND MAINTENANCE INSTRUCTIONS IN THE OWNER'S MANUAL WITH THIS UNIT.

SAFETY INSTRUCTIONS

All the safety and operating instructions should be read before the product is operated.

Read all of the instructions given here and retain them for later use. Unplug this projector from AC power supply before cleaning. Do not use liquid or aerosol cleaners. Use a damp cloth for cleaning.

Follow all warnings and instructions marked on the projector.

For added protection to the projector during a lightning storm, or when it is left unattended and unused for long periods of time, unplug it from the wall outlet. This will prevent damage due to lightning and power line surges.

Do not expose this unit to rain or use near water... for example, in a wet basement, near a swimming pool, etc...

Do not use attachments not recommended by the manufacturer as they may cause hazards.

Do not place this projector on an unstable cart, stand, or table. The projector may fall, causing serious injury to a child or adult, and serious damage to the projector. Use only with a cart or stand recommended by the manufacturer, or sold with the projector. Wall or shelf mounting should follow the manufacturer's instructions, and should use a mounting kit approved by the manufacturers.

An appliance and cart combination should be moved with care. Quick stops, excessive force, and uneven surfaces may cause the appliance and cart combination to overturn.



Slots and openings in the back and bottom of the cabinet are provided for ventilation, to insure reliable operation of the equipment and to protect it from overheating.

The openings should never be covered with cloth or other materials, and the bottom opening should not be blocked by placing the projector on a bed, sofa, rug, or other similar surface. This projector should never be placed near or over a radiator or heat register.

This projector should not be placed in a built-in installation such as a book case unless proper ventilation is provided.

Never push objects of any kind into this projector through cabinet slots as they may touch dangerous voltage points or short out parts that could result in a fire or electric shock. Never spill liquid of any kind on the projector.

This projector should be operated only from the type of power source indicated on the marking label. If you are not sure of the type of power supplied, consult your authorized dealer or local power company.

Do not overload wall outlets and extension cords as this can result in fire or electric shock. Do not allow anything to rest on the power cord. Do not locate this projector where the cord may be damaged by persons walking on it.

Do not attempt to service this projector yourself as opening or removing covers may expose you to dangerous voltage or other hazards. Refer all servicing to qualified service personnel.

Unplug this projector from wall outlet and refer servicing to qualified service personnel under the following conditions:

- a. When the power cord or plug is damaged or frayed.
- b. If liquid has been spilled into the projector.
- c. If the projector has been exposed to rain or water.
- d. If the projector does not operate normally by following the operating instructions. Adjust only those controls that are covered by the operating instructions as improper adjustment of other controls may result in damage and will often require extensive work by a qualified technician to restore the projector to normal operation.
- e. If the projector has been dropped or the cabinet has been damaged.
- f. When the projector exhibits a distinct change in performance-this indicates a need for service.

When replacement parts are required, be sure the service technician has used replacement parts specified by the manufacturer that have the same characteristics as the original part. Unauthorized substitutions may result in fire, electric shock, or injury to persons.

Upon completion of any service or repairs to this projector, ask the service technician to perform routine safety checks to determine that the projector is in safe operating condition.

Voor de klanten in Nederland



Bij dit product zijn batterijen geleverd. Wanneer deze leeg zijn, moet u ze niet weggooien maar inleveren als KCA.

COMPLIANCES

Federal Communication Commission Notice

Multimedia Projector, Model : LV-S2U, LV-S2E

This device complies with Part 15 of the FCC Rules. Operation is subject to the following two conditions:

- (1) This device may not cause harmful interference, and
- (2) this device must accept any interference received, including interference that may cause undesired operation.

Note : This equipment has been tested and found to comply with the limits for a Class B digital device, pursuant to part 15 of the FCC Rules. These limits are designed to provide reasonable protection against harmful interference in a residential installation. This equipment generates, uses and can radiate radio frequency energy and, if not installed and used in accordance with the instructions, may cause harmful interference to radio communications. However, there is no guarantee that interference will not occur in a particular installation. If this equipment does cause harmful interference to radio or television reception, which can be determined by turning the equipment off and on, the user is encouraged to try to correct the interference by one or more of the following measures :

- Reorient or relocate the receiving antenna.
- Increase the separation between the equipment and receiver.
- Connect the equipment into an outlet on a circuit different from that to which the receiver is connected.
- Consult the dealer or an experienced radio/TV technician for help.

Use of shielded cable is required to comply with class B limits in Subpart B of Part 15 of FCC Rules.

Do not make any changes or modifications to the equipment unless otherwise specified in the instructions. If such changes or modifications should be made, you could be required to stop operation of the equipment.

Canon U.S.A., Inc.

One Canon Plaza, Lake Success, NY 11042, U.S.A.

Tel No. (516)328-5600

For use in Germany

This product is intended for use in residential, commercial and light industry environment.

Canadian Radio Interference Regulations

This Class B digital apparatus meets all requirements of the Canadian Interference-Causing Equipment Regulations.

AC POWER CORD REQUIREMENT

The AC Power Cord supplied with this projector meets the requirement for use in the country you purchased it.

AC Power Cord for the United States and Canada :

AC Power Cord used in the United States and Canada is listed by the Underwriters Laboratories (UL) and certified by the Canadian Standard Association (CSA).

AC Power Cord has a grounding-type AC line plug. This is a safety feature to be sure that the plug will fit into the power outlet. Do not try to defeat this safety feature. Should you be unable to insert the plug into the outlet, contact your electrician.

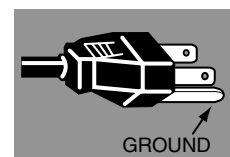

THE SOCKET-OUTLET SHOULD BE INSTALLED NEAR THE EQUIPMENT AND EASILY ACCESSIBLE.

TABLE OF CONTENTS

FEATURES AND DESIGN 6

PREPARATION 7

NOMENCHTOR	7
SETTING-UP THE PROJECTOR	8
CONNECTING AC POWER CORD	8
POSITIONING THE PROJECTOR	9
ADJUSTABLE FEET	9
MOUNTING THE LENS COVER	10
MOVING THE PROJECTOR	10

CONNECTING THE PROJECTOR 11

TERMINALS OF THE PROJECTOR	11
CONNECTING TO A COMPUTER	12
CONNECTING VIDEO EQUIPMENT	13

BEFORE OPERATION 14

OPERATION OF THE REMOTE CONTROL UNIT	14
OPERATING RANGE	15
REMOTE CONTROL UNIT BATTERY INSTALLATION	15
TOP CONTROLS AND INDICATORS	16
OPERATING THE ON-SCREEN MENU	17
HOW TO OPERATE THE ON-SCREEN MENU	17
FLOW OF ON-SCREEN MENU OPERATION	17
MENU BAR	18

BASIC OPERATION 19

TURNING ON / OFF THE PROJECTOR	19
TURNING ON THE PROJECTOR	19
TURNING OFF THE PROJECTOR	19
ADJUSTING THE SCREEN	20
ZOOM ADJUSTMENT	20
FOCUS ADJUSTMENT	20
KEystone ADJUSTMENT	20
PICTURE FREEZE FUNCTION	20
NO SHOW FUNCTION	21
P-TIMER FUNCTION	21
SOUND ADJUSTMENT	21

COMPUTER INPUT 22

SELECTING THE INPUT SOURCE	22
SELECTING THE COMPUTER SYSTEM	22
COMPATIBLE COMPUTER SPECIFICATIONS	23
PC ADJUSTMENT	24
AUTO PC ADJUSTMENT	24
MANUAL PC ADJUSTMENT	25
PICTURE IMAGE ADJUSTMENT	27
IMAGE LEVEL SELECT	27
IMAGE LEVEL ADJUSTMENT	28
PICTURE SCREEN ADJUSTMENT	29

VIDEO INPUT 30

SELECTING THE INPUT SOURCE	30
SELECTING THE VIDEO SYSTEM	31
PICTURE IMAGE ADJUSTMENT	32
IMAGE LEVEL SELECT	32
IMAGE LEVEL ADJUSTMENT	33
PICTURE SCREEN ADJUSTMENT	34

SETTING 35

SETTING MENU	35
--------------	----

APPENDIX 37

LAMP REPLACEMENT	37
LAMP REPLACE	37
LAMP REPLACE COUNTER	38
MAINTENANCE	39
WARNING TEMP. INDICATOR	39
AIR FILTER CARE AND CLEANING	39
CLEANING PROJECTION LENS	39
TROUBLESHOOTING	40
TECHNICAL SPECIFICATIONS	42
OPTIONAL PARTS	42
CONFIGURATIONS OF TERMINALS	43

TRADEMARKS

- Apple, Macintosh, and PowerBook are trademarks or registered trademarks of Apple Computer, Inc.
- IBM, VGA, XGA, and PS/2 are trademarks or registered trademarks of International Business Machines, Inc.
- Windows and PowerPoint are registered trademarks of Microsoft Corporation.
- Each name of corporations or products in the owner's manual is a trademark or a registered trademark of its respective corporation.

FEATURES AND DESIGN

This Multimedia Projector is designed with the most advanced technology for portability, durability, and ease of use. It utilizes built-in multimedia features, a palette of 16.77 million colors, and matrix liquid crystal display (LCD) technology.

◆ Wide Zoom Lens

This projector is equipped with a Wide Zoom Lens with a 1.4 times optical zoom, and provides a 100" screen size at a range of 9.2' (2.8m) to 13.1' (4m).

◆ Compact Design

This projector is extremely compact in size and weight. It is designed to be carried and work anywhere.

◆ Compatibility

This projector accepts a wide range of video and computer input signals including;

- **Computers**
IBM-compatible or Macintosh computer up to 1280 x 1024 resolution.
- **6 Color TV Systems**
NTSC, PAL, SECAM, NTSC 4.43, PAL-M or PAL-N color system can be connected.
- **Component Video**
Component video signal, such as a DVD player output high definition TV signals including 480i, 480p, 575i, 575p, 720p, 1035i or 1080i, can be connected.
- **S-Video**
S-Video signal, such as a S-VHS VCR or camcorder, can be connected.

◆ High Resolution Image

This projector provides 800 x 600 dots resolution for computer input and 500 horizontal TV lines. Resolution from a computer between SVGA (800 x 600) and XGA (1024 x 768) is compressed into 800 x 600 dots. This projector cannot display image of over 1280 x 1024 dots. When resolution of your computer is higher than 1280 x 1024, reset a computer output for lower resolution.

◆ Multi-Scan System

This projector has a Multi-Scan System to conform to recognition of almost all computer output signals allowing quick. Making manual adjustment of frequency and other settings unnecessary.

◆ One-Touch Auto PC Adjustment

Incoming computer video signals are recognized and the best adjustment is automatically set by Auto PC Adjustment.

◆ Digital Zoom (for Computer)

A Digital Zoom function lets you enlarge a sect of the image to 16 times, allowing you to focus on crucial information at a presentation.

◆ Keystone Correction

Positioning height of a projector may result in distorted image being displayed in a trapezoid shape. Keystone Correction solves this problem by digitally altering projection to produce undistorted images.

◆ Power Management

Power Management function reduces power consumption while the projector is not in use. This Power Management function operates to turn the Projection Lamp off when a signal has not been received or a button is not pressed over 5 minutes. Projection Lamp is automatically turned on again when a projector detects a signal or a button is pressed. This projector is shipped with this function ON.

◆ Multilanguage Menu Display

Operation menu is displayed in; English, German, French, Italian, Spanish, Portuguese, Dutch, Swedish, Chinese, Korean or Japanese.

NOMENCHTOR

FRONT

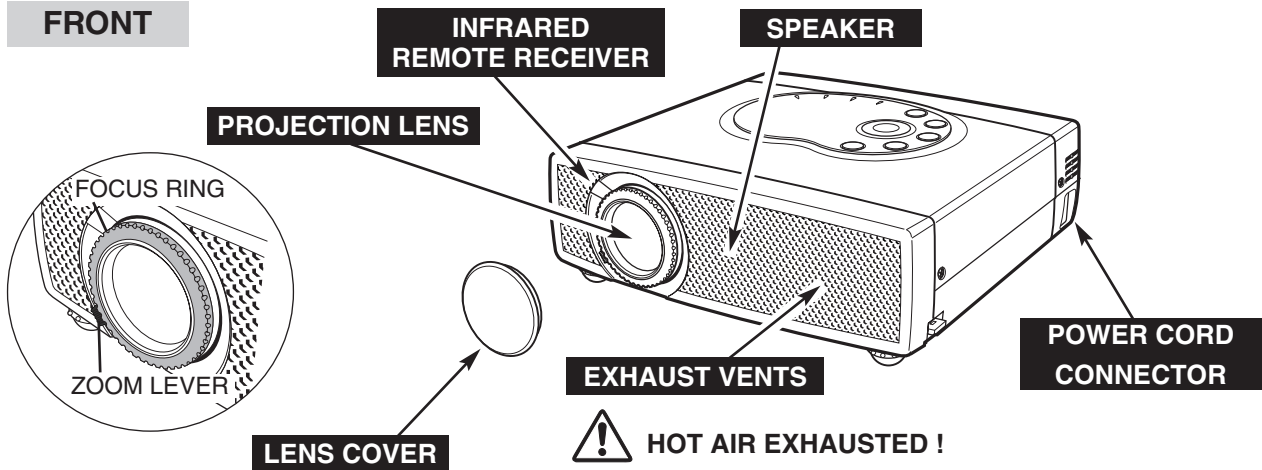

! HOT AIR EXHAUSTED !

Air blown from Exhaust Vents is hot. When using or installing the projector, the following precautions should be taken.

- Do not put any flammable object near these vents.
- Keep front grills at least 3'(1m) away from any object, especially heat-sensitive objects.
- Do not touch this area, especially screws and metallic parts. This area becomes hot while the projector is used.

This projector detects internal temperature and automatically controls operating power of Cooling Fans.

BACK

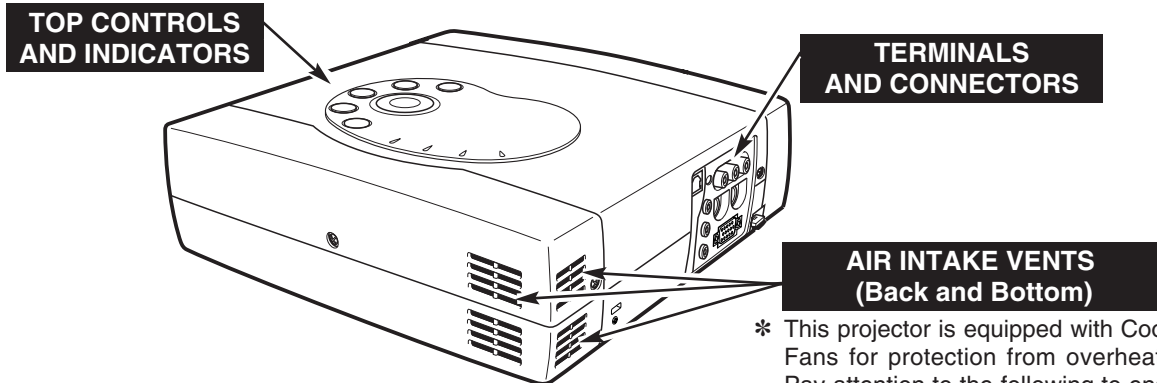

* This projector is equipped with Cooling Fans for protection from overheating. Pay attention to the following to ensure proper ventilation and avoid a possible risk of fire and malfunction.

- Do not cover vent slots.
- Keep back and bottom clear of any object. Obstructions may block cooling air.

BOTTOM

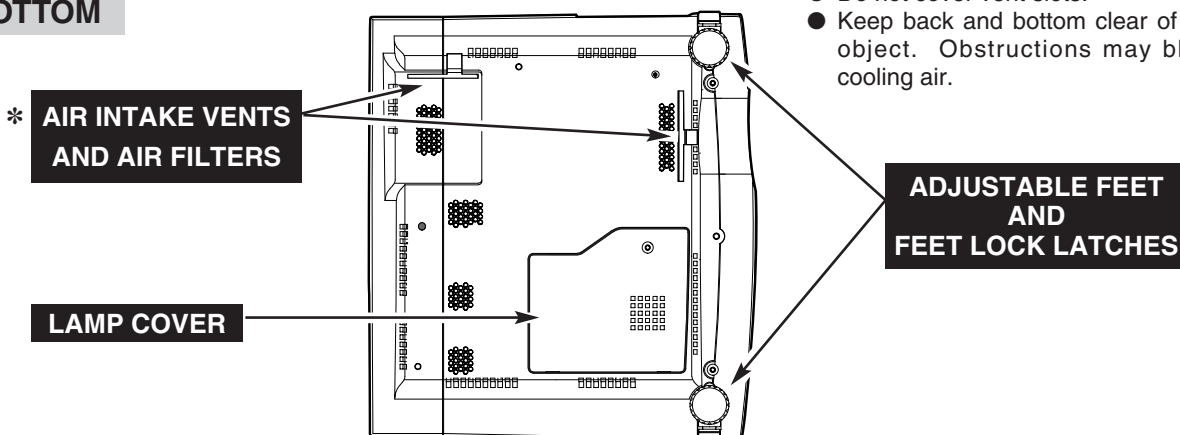

SETTING-UP THE PROJECTOR

CONNECTING AC POWER CORD

This projector uses nominal input voltages of 100-120 V or 200-240 V AC. This projector automatically selects the correct input voltage. It is designed to work with single-phase power systems having a grounded neutral conductor. To reduce risk of electrical shock, do not plug into any other type of power system. Consult your authorized dealer or service station if you are not sure of the type of power being supplied. Connect a projector with all peripheral equipment before turning a projector on. (Refer to pages 11 ~ 13 for connection.)

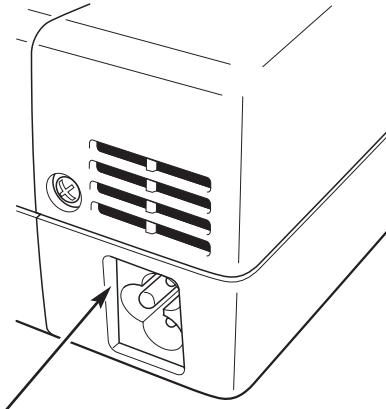

Connect AC Power Cord (supplied) to a projector. The AC outlet must be near this equipment and must be easily accessible.



CAUTION

For safety, unplug AC Power Cord when the projector is not in use.
When this projector is connected to the outlet with AC Power Cord, it is in Stand-by Mode and consumes a little electric power.

NOTE ON THE POWER CORD

AC Power Cord must meet requirements of the country where the projector is used. Confirm an AC plug type with the chart below and proper AC Power Cord must be used. If the supplied AC Power Cord does not match your AC outlet, contact your sales dealer.

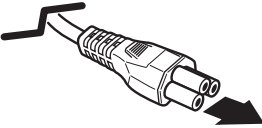
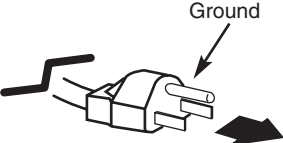
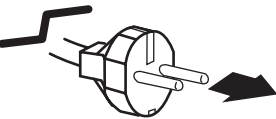
Projector side	AC Outlet side	
 <p data-bbox="375 1373 592 1444">To POWER CORD CONNECTOR on your projector.</p>	<p data-bbox="630 1171 935 1201">For the U.S.A. and Canada</p>  <p data-bbox="760 1381 927 1432">To the AC Outlet. (120 V AC)</p>	<p data-bbox="963 1171 1255 1201">For Continental Europe</p>  <p data-bbox="1081 1398 1265 1449">To the AC Outlet. (200 - 240 V AC)</p>

POSITIONING THE PROJECTOR

- This projector is designed to project on a flat projection surface.
- The projector can be focused from 3.6'(1.1m) ~ 26.2'(8m).
- Refer to the figure below to adjust a screen size.

ROOM LIGHT

The brightness of a room has a great impact on picture quality. It is recommended to limit ambient lighting to provide the best image.

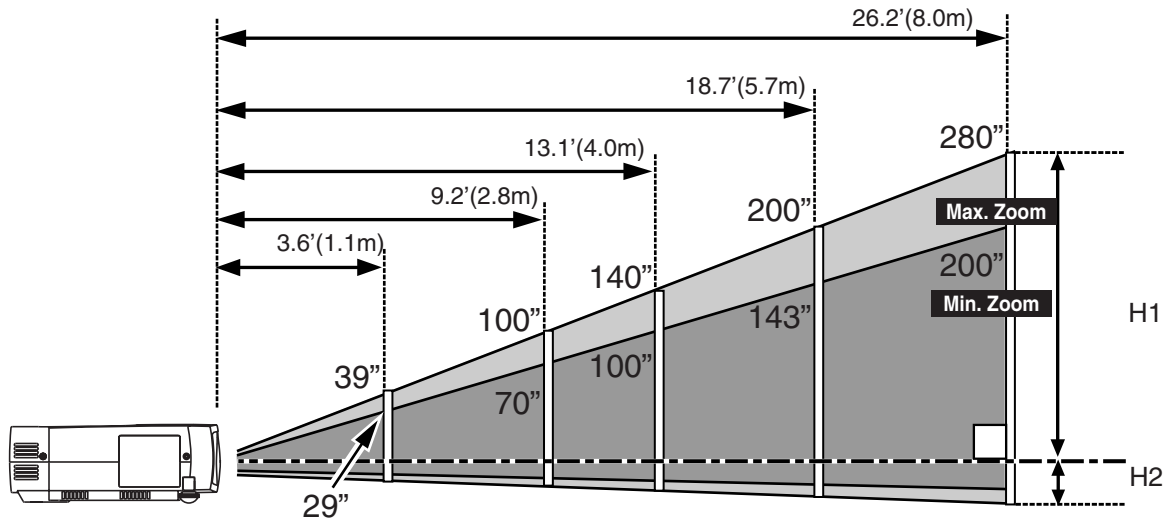

Screen Size (W x H) mm	29"	50"	100"	150"	200"
Zoom (min)	3.6' (1.1m)	6.6' (2.0m)	13.1' (4.0m)	19.7' (6.0m)	26.2' (8.0m)
Zoom (max)	—	4.6' (1.4m)	9.2' (2.8m)	14.1' (4.3m)	18.7' (5.7m)

* The projection maximum screen size is 200".

ADJUSTABLE FEET

Picture tilt and projection angle can be adjusted by rotating the ADJUSTABLE FEET. Projection angle can be adjusted to approx. 10 degrees.

- 1 Lift the front of the projector and pull the FEET LOCK LATCHES on both sides of a projector.
- 2 Release the FEET LOCK LATCHES to lock the ADJUSTABLE FEET and rotate the ADJUSTABLE FEET to adjust position and tilt.
- 3 To retract the ADJUSTABLE FEET, lift the front of the projector and pull the FEET LOCK LATCHES and push to feet upward.
Keystone distortion of a projected image can be adjusted by Menu Operation. (Refer to P20 and 35.)

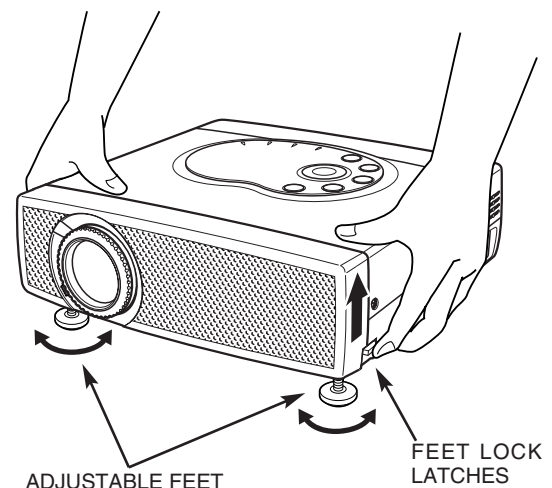

CAUTION

Avoid positioning a projector with the angle of more than 20 degrees. Projection Lamp may malfunction.

MOUNTING THE LENS COVER

When transporting the projector or when it is not used for an extended period of time, attach the Lens Cover. Before attaching the Lens Cover, be sure to turn the projector off and disconnect the AC Power cord from the AC outlet.

- 1 Secure the Strap for the Lens Cover through the hole.
- 2 Turn the projector upside down and secure the Strap for the Lens Cover to the bottom of projector with a screw.

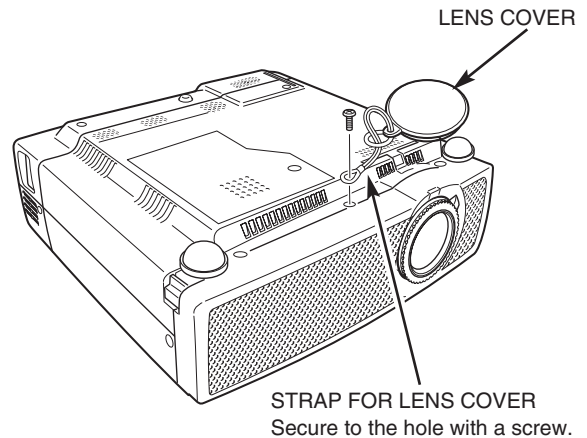

MOVING THE PROJECTOR

When moving a projector, attach the Lens Cover and retract the Adjustable Feet to prevent damage to the lens and cabinet. When the projector is not in use for an extended period, put it into the case (carrying bag) supplied with the projector.



CAUTION

Carrying Bag (supplied) is intended for protection from dust and scratches on the surface of a cabinet, and it is not designed to protect the projector from external forces. Do not transport a projector through a courier or transport services with this bag, otherwise the projector can be damaged. When handling a projector, do not drop, bump, subject it to strong forces or put other things on the cabinet.



CAUTION IN CARRYING OR TRANSPORTING THE PROJECTOR

- Do not drop or bump a projector, otherwise damage or malfunction may result.
- When carrying a projector, use a suitable carrying case.
- Do not transport a projector by using a courier or transport service in an unsuitable transport case. This may cause damage to the projector. To transport the projector through a courier or transport service, consult your dealer.

CONNECTING THE PROJECTOR

TERMINALS OF THE PROJECTOR

This projector has input and output terminals on its side for connecting computer and video equipment. Refer to figures on pages 11 to 13 for these connections.

USB CONNECTOR (Series B)

When controlling a computer with the optional Wireless Remote Control Unit, connect the USB port of the computer to this connector. The Remote Control Unit supplied with the projector can not control a computer. Consult your dealer for details. (Refer to P12.)

RESET BUTTON

The projector uses a micro processor for control and occasionally, need to be reset. This can be done by pressing the RESET button with a pen, which will shut down and restart the unit. Do not use the RESET function excessively.

VIDEO INPUT JACKS

Connect the composite video output from your video equipment to VIDEO/Y jack or connect the component video outputs to VIDEO/Y, Pb/Cb and Pr/Cr jacks. (Refer to P13.)

S-VIDEO INPUT JACK

Connect the S-VIDEO output from your video equipment to this jack. (Refer to P13.)

CONTROL PORT CONNECTOR

When controlling a computer with the optional Wireless Remote Control Unit, connect the mouse port of the computer to this connector. The Remote Control Unit supplied with the projector can not control a computer. Consult your dealer for details. (Refer to P12.)

RGB INPUT TERMINAL (ANALOG)

Connect the computer output to this jack. (Refer to P12.)

COMPUTER AUDIO INPUT JACK

Connect the audio output (stereo) from the computer to this jack. (Refer to P12.)

AUDIO OUTPUT JACK

Connect an external audio amplifier to this jack. (Refer to P12, 13.)

AUDIO INPUT JACK

Connect the audio output from your video equipment to this jack. (Refer to P13.)

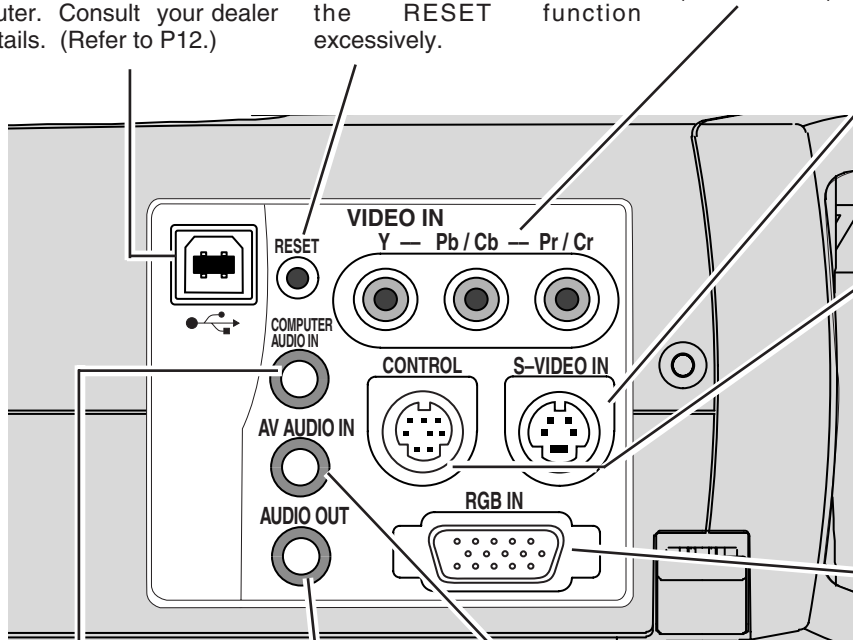

CONNECTING TO A COMPUTER

Cables used for connection (* = Cable or adapter is not supplied with this projector.)

- VGA Cable (HDB 15 pin)
- Control Cable for PS/2 Port *, Serial Port *, or ADB Port *
- USB Cable *
- MAC Adapter (When connecting to Macintosh computer) *
- Audio Cable (Mini Plug (stereo) x 1) *

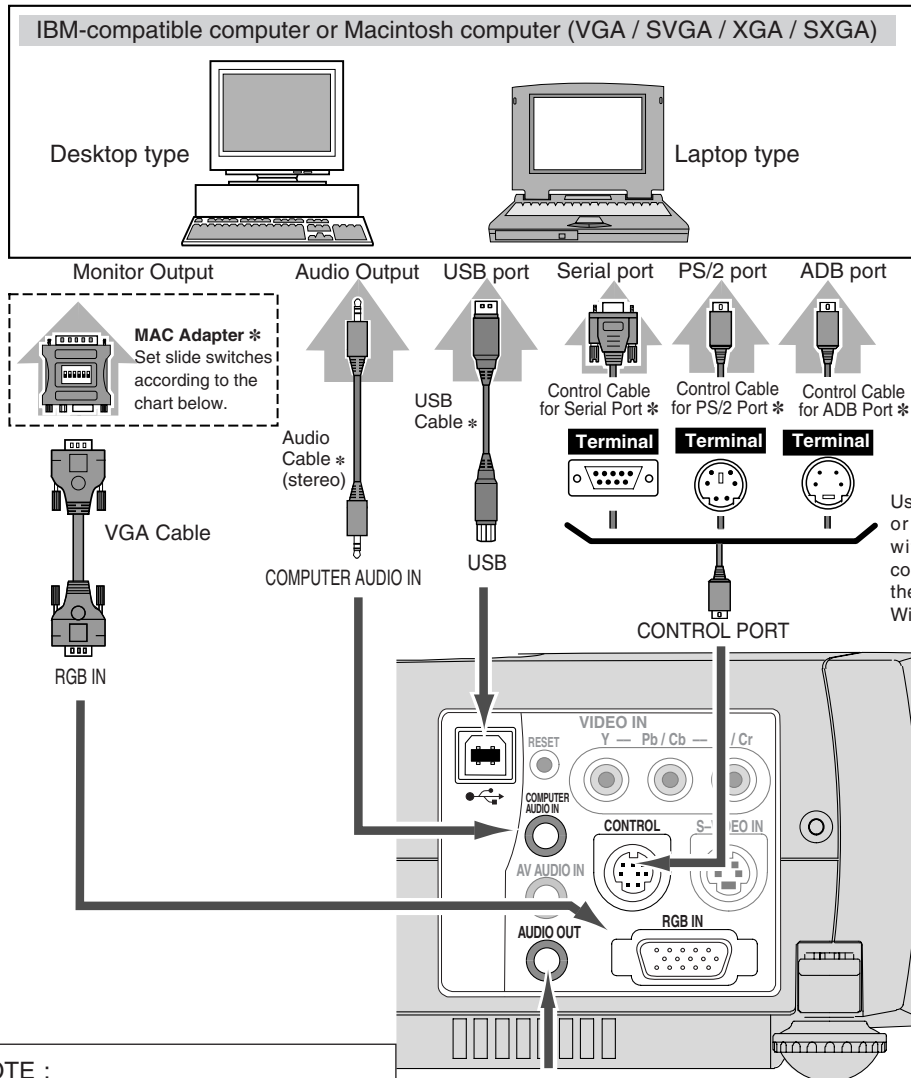

Use one of these Control Cables or USB Cable corresponding with the terminal of your computer only when controlling the computer with the optional Wireless Remote Control Unit.

NOTE :
When connecting the cable, the power cords of both the projector and the external equipment should be disconnected from AC outlet. Turn the projector and peripheral equipment on before the computer is switched on.

Terminals of the Projector

◆ MAC ADAPTER (Not supplied)

Set switches as shown in the table below depending on RESOLUTION MODE that you want to use before you turn on projector and computer.

	1	2	3	4	5	6
13" MODE (640 x 480)	ON	ON	OFF	OFF	OFF	OFF
16" MODE (832 x 624)	OFF	ON	OFF	ON	OFF	OFF
19" MODE (1024 x 768)	OFF	ON	ON	OFF	OFF	OFF
21" MODE (1152 x 870)	ON	ON	ON	ON	OFF	OFF

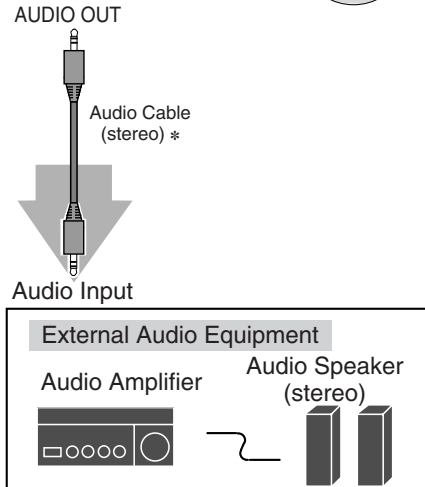

CONNECTING VIDEO EQUIPMENT

Cables used for connection (* = Cable is not supplied with this projector.)

- Video Cable (RCA x 1 or RCA x 3) *
- S-VIDEO Cable *
- Audio Cable (Mini Plug (stereo) x 1) *

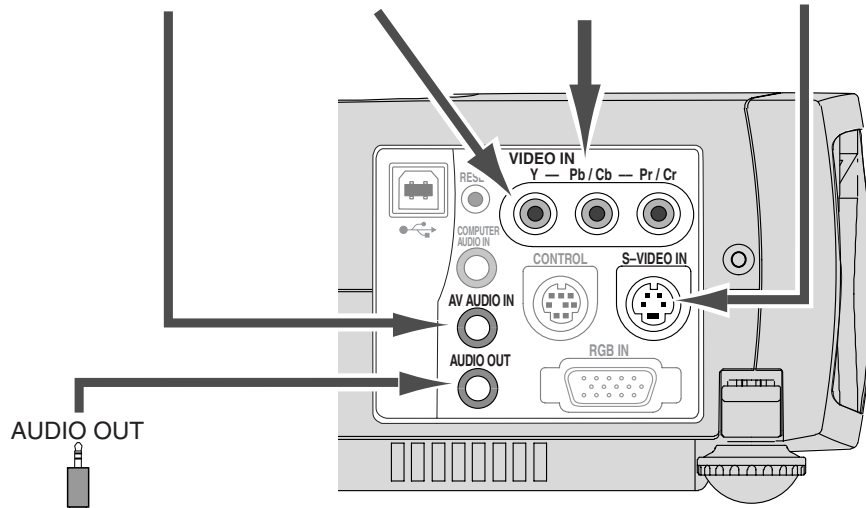
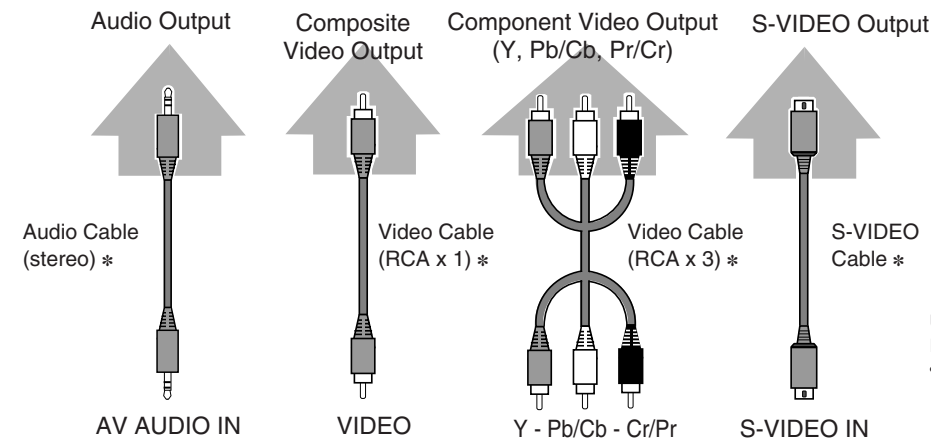
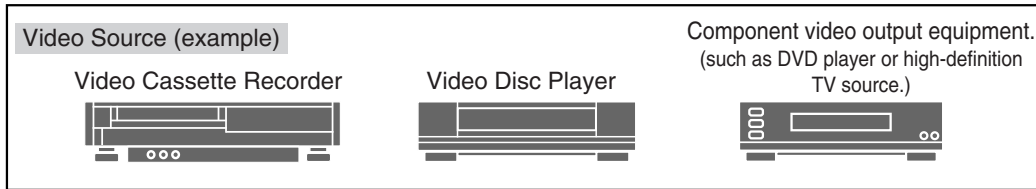

Use any of VIDEO jack Y-Pb/Cb-Pr/Cr jacks or S-VIDEO jack.

- When both VIDEO jack and S-VIDEO jack are connected, S-VIDEO jack has priority over VIDEO jack.
- When both Y-Pb/Cb-Pr/Cr jacks and S-VIDEO jack are connected, Y-Pb/Cb-Pr/Cr jacks has priority over S-VIDEO jack.

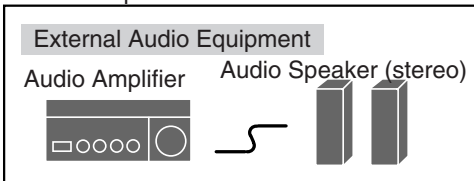
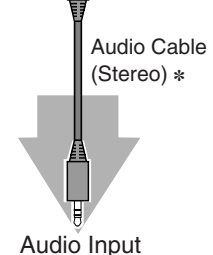

Terminals of the Projector

NOTE : When connecting the cable, the power cords of both the projector and the external equipment should be disconnected from AC outlet.

OPERATION OF THE REMOTE CONTROL UNIT

Infrared signals transmitted from this point.

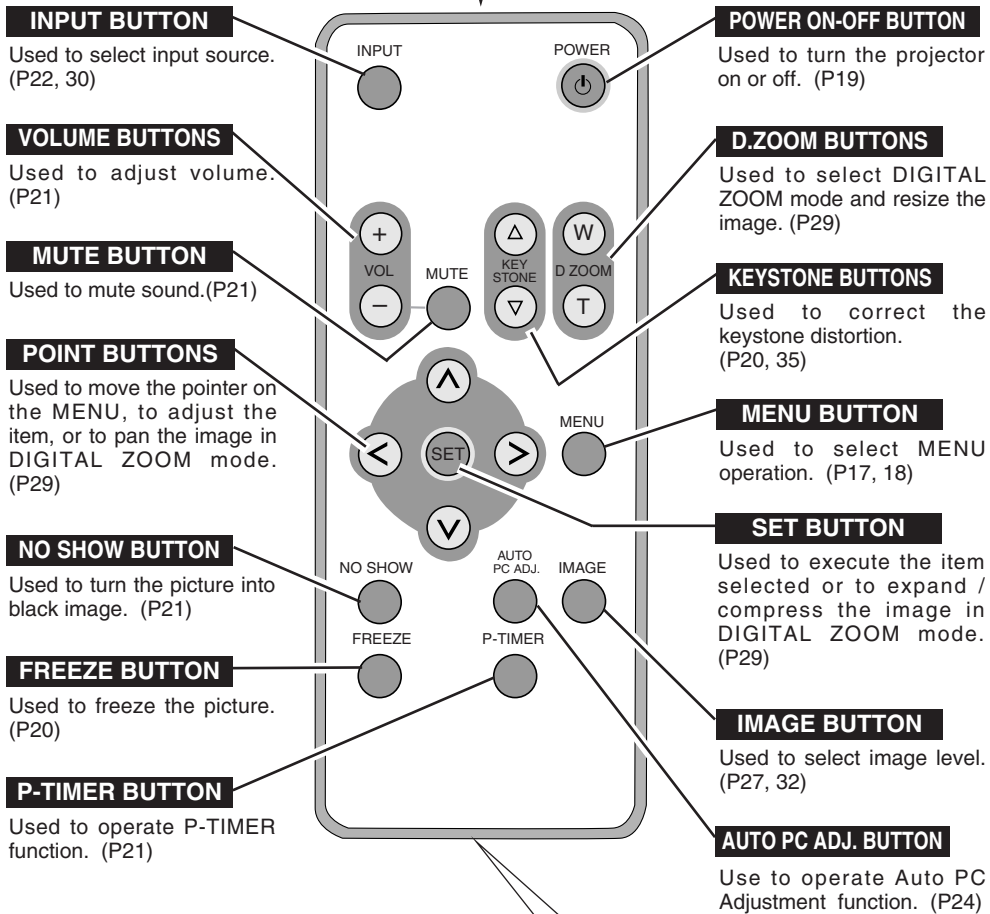

To insure safe operation, please observe the following precautions :

- Do not bend, drop Remote Control Unit, or expose Remote Control Unit to moisture or heat.
- For cleaning, use soft dry cloth. Do not apply benzene, thinner, splay or any chemical material.

Battery is installed in Remote Control Unit.

Before operation, pull out and remove a protect sheet from Remote Control Unit. This sheet protecting discharge of a battery.

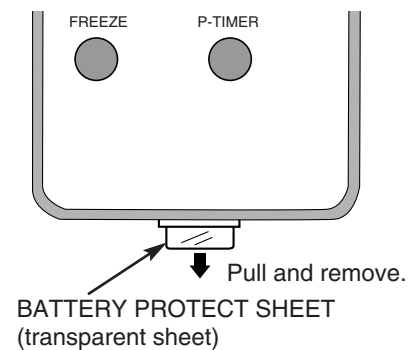

OPERATING RANGE

Point Remote Control Unit toward projector (Receiver Window) whenever pressing any button. Maximum operating range for Remote Control Unit is about 16.4' (5m) and 60° in front of the projector.

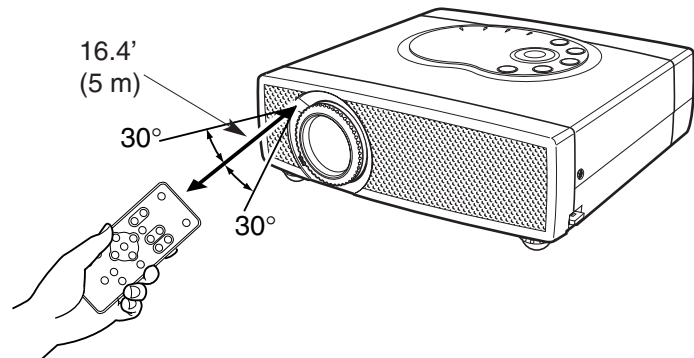

REMOTE CONTROL UNIT BATTERY INSTALLATION

1 Pull out Battery Holder.

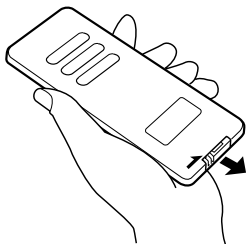

2 Replace with new battery. Install with battery (+), (-) marks properly.

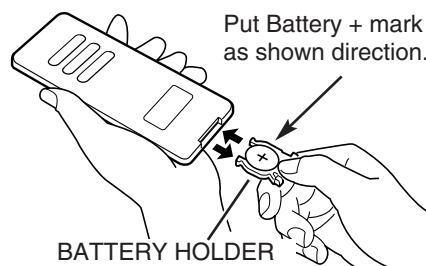

3 Install battery and Battery Holder into Remote Control Unit.

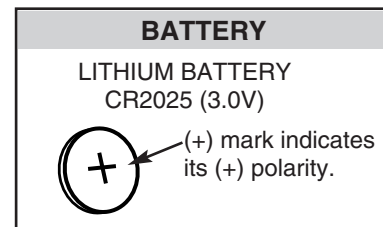

To insure safe operation, please observe the following precautions :

- Use only specified battery. Improper battery may cause malfunction of Remote Control Unit.
- Be sure to install battery with correct polarity.
- Do not expose a battery to moisture or heat. Do not charge a battery.
- If a battery has leaked on the Remote Control Unit, carefully wipe the case clean and load a new battery.
- Keep a battery away from children to avoid swallowing it accidentally.
- Risk of explosion if battery is replaced by an incorrect type.
- Dispose of used batteries according to the instructions.

TOP CONTROLS AND INDICATORS

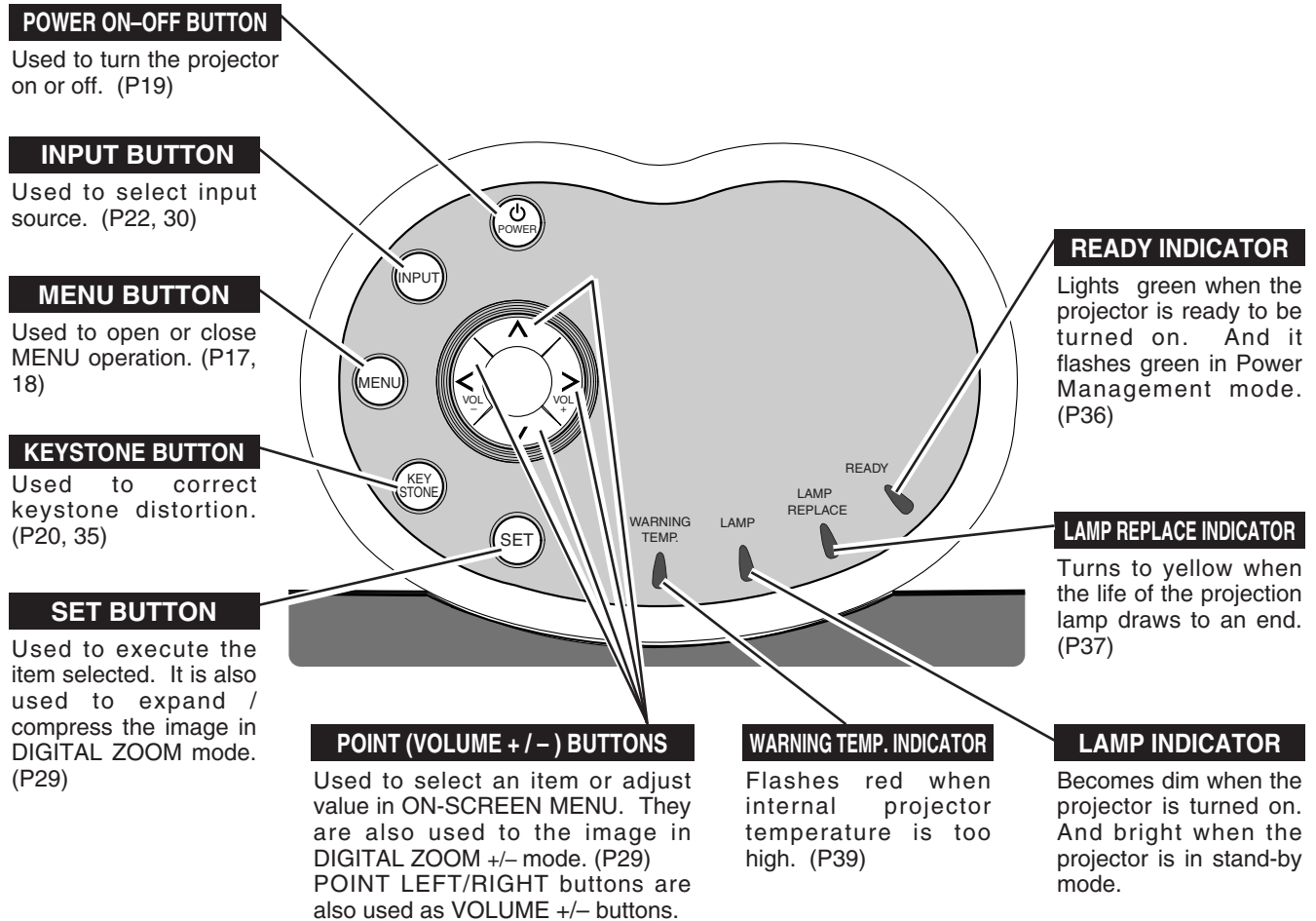

OPERATING THE ON-SCREEN MENU

HOW TO OPERATE THE ON-SCREEN MENU

You can control and adjust this projector through the ON-SCREEN MENU. Refer to the following pages to operate each adjustment on ON-SCREEN MENU.

DISPLAY MENU

- 1 Press MENU button to display ON-SCREEN MENU.

MOVING POINTER

- 2 Move the pointer (* see below) or adjust the value of item by pressing POINT button(s) on Top Control or on Remote Control Unit.

* Pointer is the icon on ON-SCREEN MENU to select the item. See the figures on the section "FLOW OF ON-SCREEN MENU OPERATION" below.

SELECT ITEM

- 3 Select the item or set selected function by pressing SET button.

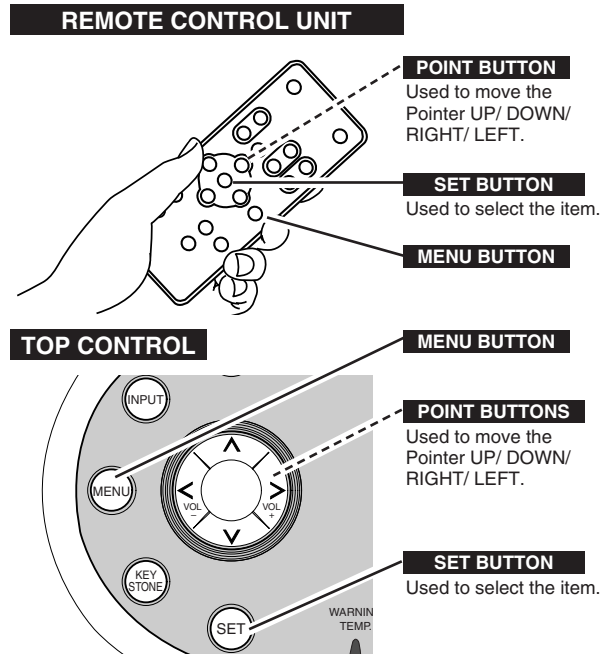

FLOW OF ON-SCREEN MENU OPERATION

Display ON-SCREEN MENU

- 1 Press MENU button to display ON-SCREEN MENU (MENU BAR). The red frame is the POINTER.

Select Menu to be adjusted

- 2 Move POINTER (red frame) to MENU ICON that you want to select by pressing POINT RIGHT / LEFT buttons.

Control or adjust item through ON-SCREEN MENU

- 3 Press POINT DOWN button and move POINTER (red frame or red arrow) to the ITEM that you want to adjust, and then press the SET button to show the DATA.
- 4 Adjust the ITEM DATA by pressing the POINT RIGHT / LEFT buttons. Refer to the following pages for details of respective adjustments.

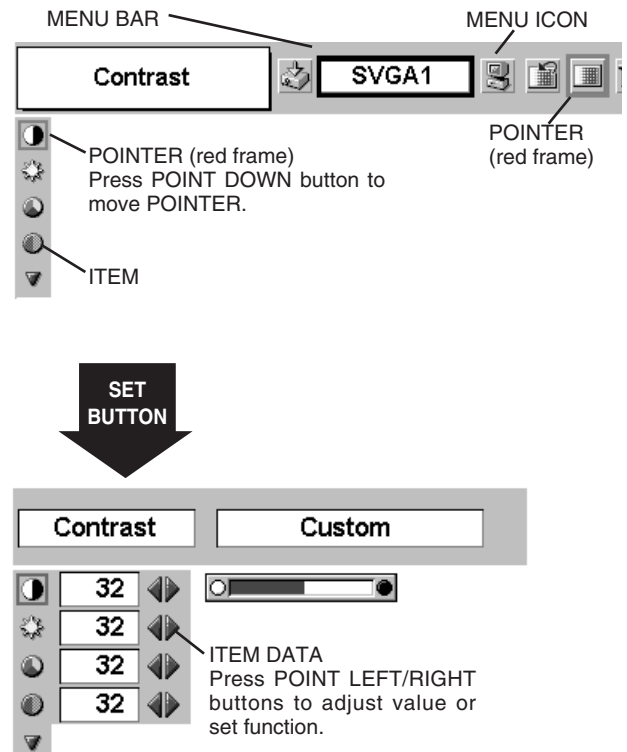

MENU BAR

FOR PC SOURCE

Press the MENU BUTTON while connected to the PC input source.

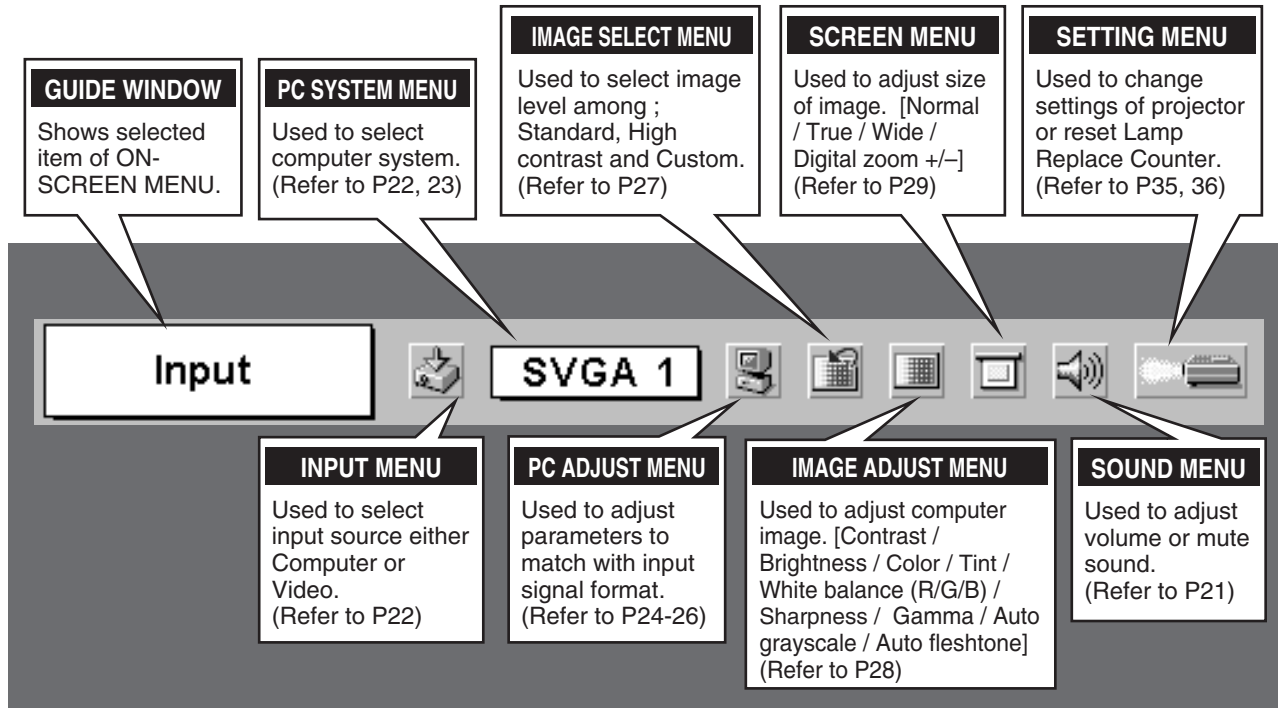

FOR VIDEO SOURCE

Press the MENU BUTTON while connecting to the VIDEO input source.

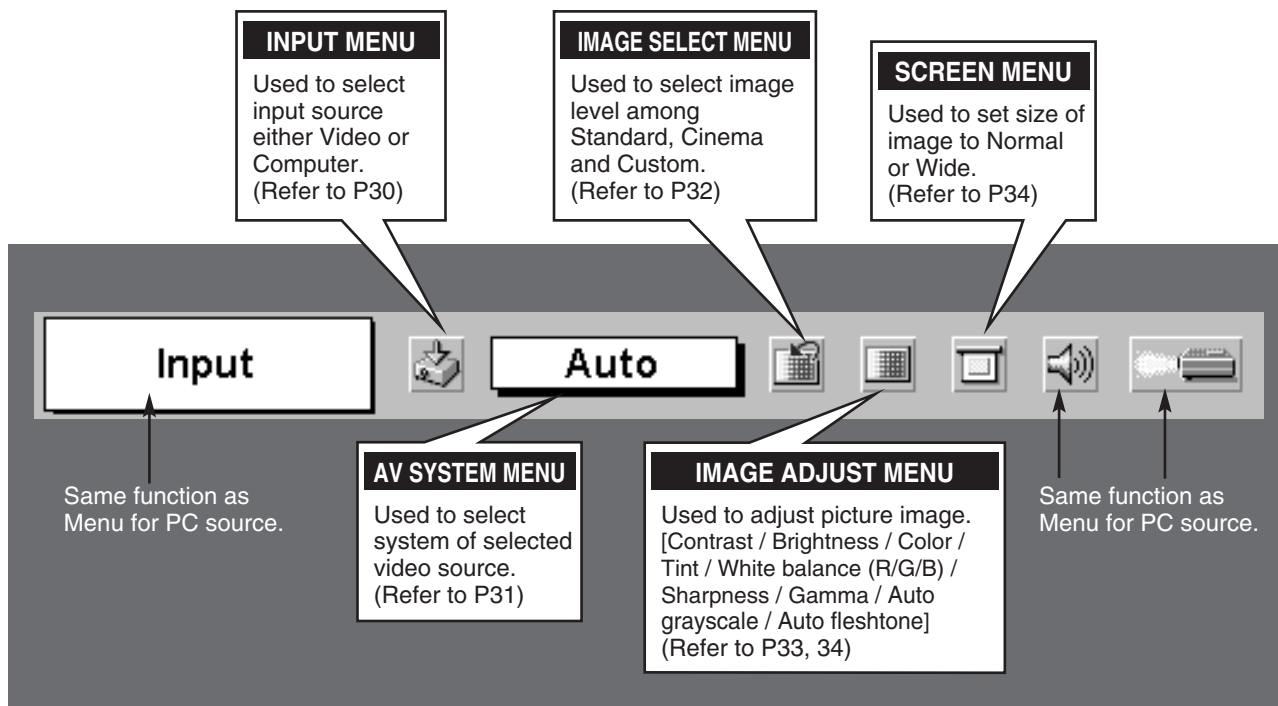

TURNING ON / OFF THE PROJECTOR

TURNING ON THE PROJECTOR

- 1 Complete peripheral connections (with Computer, VCR, etc.) before turning on the projector. (Refer to "CONNECTING PROJECTOR" on page 11~13 for connecting the equipment.)
- 2 Connect the projector's AC Power Cord into an AC outlet. LAMP Indicator lights red, and READY Indicator lights green.
- 3 Press POWER ON-OFF button on Top Control or on Remote Control Unit to ON. LAMP Indicator dims, and Cooling Fans start to operate. Preparation Display appears on a screen and the count-down starts. The signal from PC or Video source appears after 30 seconds. And then current image level is displayed on screen for 4 seconds.

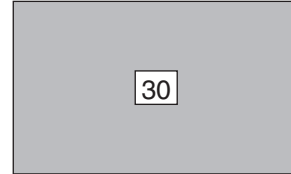

Preparation Display disappears after 30 seconds.

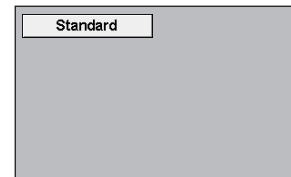

Current image level is displayed on screen for 4 seconds.

TURNING OFF THE PROJECTOR

- 1 Press POWER ON-OFF button on Top Control or on Remote Control Unit, and a message "Power off?" appears on a screen.
- 2 Press POWER ON-OFF button again to turn off the projector. LAMP Indicator lights bright and READY Indicator turns off. After the projector is turned off, Cooling Fans operate (for 90 seconds).
- 3 When the projector has cooled down, READY Indicator lights green again.

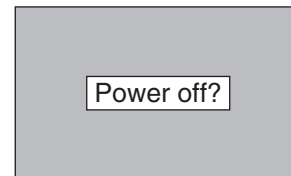

Message disappears after 4 seconds.

NOTE : Projector cannot be turned on during cooling period with READY Indicator off. You can turn it on again after READY Indicator lights green.



TO MAINTAIN THE LIFE OF LAMP, ONCE YOU TURN PROJECTOR ON, WAIT AT LEAST 5 MINUTES BEFORE TURNING IT OFF.
DO NOT DISCONNECT AC POWER CORD BEFORE READY INDICATOR LIGHTS GREEN.

note on operation

When "Power management" function is ON, the projector detects signal interruption and turns off Projection Lamp automatically. Refer to "Power management" on page 36.

When WARNING TEMP. Indicator flashes red, the projector is automatically turned off. Wait at least 5 minutes before turning on the projector again.

When WARNING TEMP. Indicator continues to flash, follow the procedures below:

1. Press POWER ON-OFF button to turn the projector off and disconnect AC Power Cord from an AC outlet.
2. Check Air Filters for dust accumulation.
3. Clean Air Filters. (See "AIR FILTER CARE AND CLEANING" section on page 39.)
4. Turn the projector on again.

If WARNING TEMP. Indicator continues to flash, contact your sales dealer or service center.

ADJUSTING THE SCREEN

ZOOM ADJUSTMENT

Move ZOOM LEVER upward to make the image larger. Move ZOOM LEVER downward to make the image smaller.

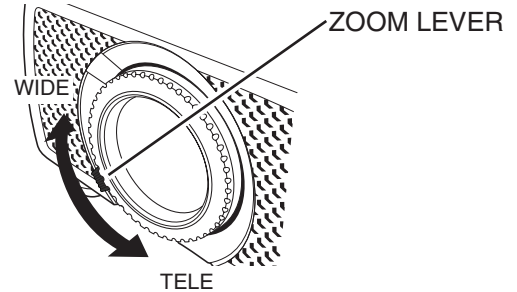

FOCUS ADJUSTMENT

Rotate the FOCUS RING to adjust the projected picture focus.

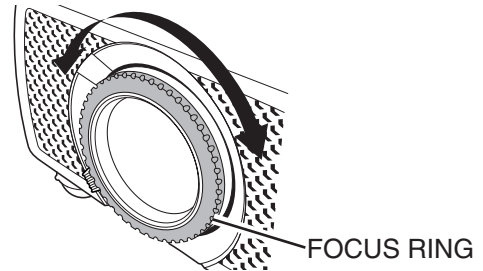

KEystone ADJUSTMENT

If a projected picture has keystone distortion, correct image with KEYSTONE adjustment.

- 1 Press KEYSTONE ▲/▼ button on Remote Control Unit or KEYSTONE button on Top Control or select Keystone on SETTING menu. (Refer to page 35.) Keystone dialog box appears.
- 2 Correct keystone distortion by pressing KEYSTONE ▲/▼ button or POINT UP/DOWN button(s). Press KEYSTONE ▲ button or POINT UP button to reduce the upper part of image, and press KEYSTONE ▼ button or POINT DOWN button to reduce the lower part.



- Arrows are white in no correction.
- Arrow of direction being corrected turns blue.
- Arrow disappears at the maximum correction.

Reduce the upper width with KEYSTONE ▲ button or POINT UP button.

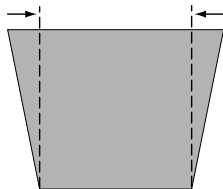

Reduce the lower width with KEYSTONE ▼ button or POINT DOWN button.

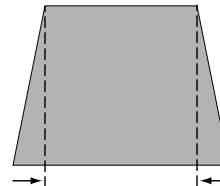

PICTURE FREEZE FUNCTION

Press the FREEZE button on the Remote Control Unit to freeze the picture on-screen. To cancel the FREEZE function, press the FREEZE button again or press any other button.

NO SHOW FUNCTION

Press the NO SHOW button on the Remote Control Unit to black out the image. To restore to normal, press the NO SHOW button again or press any other button.

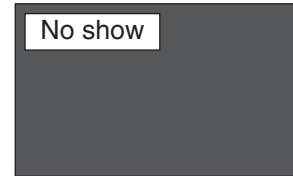

Message disappears after 4 seconds.

P-TIMER FUNCTION

Press the P-TIMER button on the Remote Control Unit. The timer display "00 : 00" appears on the screen and the timer starts to count time (00 : 00 ~ 59 : 59).

To stop the P-TIMER display, press the P-TIMER button. Press the P-TIMER button again to cancel the P-TIMER function.



SOUND ADJUSTMENT

DIRECT OPERATION

Volume

Press the VOLUME (+/-) button(s) on the Remote Control Unit or POINT LEFT / RIGHT (VOL -/+) button on Top Control to adjust volume. The volume dialog box appears on the screen for a few seconds.

Use the VOLUME (+) or POINT RIGHT (VOL +) button to increase volume, and VOLUME (-) or POINT LEFT (VOL -) button for decreasing.

Mute

Press MUTE button on Remote Control Unit to cut off the sound. To restore sound to its previous level, press MUTE button again or press Volume (+/-) or POINT LEFT / RIGHT (VOL -/+) button(s).

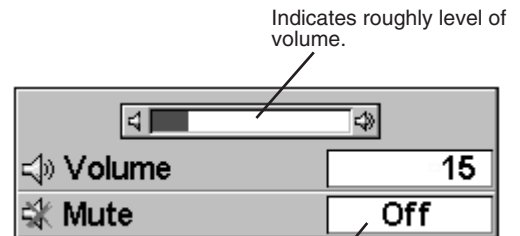

Indicates roughly level of volume.

Press MUTE button to set Mute function On or Off.

The display disappears after 4 seconds.

MENU OPERATION

1 Press the MENU button and the ON-SCREEN MENU will appear. Press the POINT LEFT/RIGHT buttons to move the red frame to SOUND Menu icon.

2 Press the POINT DOWN button to move the red frame to the item that you want to select, and then press SET button.



Volume

To increase the volume, press the POINT RIGHT (VOL +) button, and press the POINT LEFT (VOL -) button for decreasing.



Mute

Press the POINT LEFT/RIGHT button(s) (VOL -/+) to cut off sound. The dialog box display is changed to "On" and sound is cut off. To restore sound to its previous level, press the POINT LEFT/RIGHT (VOL -/+) button(s) again.

SOUND MENU

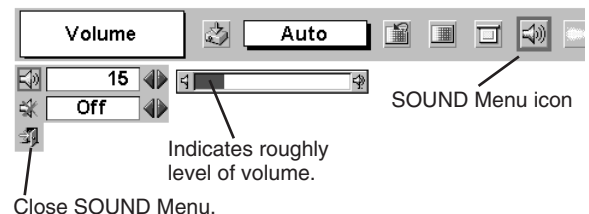

SOUND Menu icon

Indicates roughly level of volume.

Close SOUND Menu.

SELECTING THE INPUT SOURCE

DIRECT OPERATION

Choose Computer by pressing the INPUT button on Top Control or on Remote Control Unit.

If the projector cannot reproduce a proper image, select correct input source through the MENU OPERATION (see below).

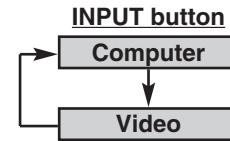

MENU OPERATION

- 1 Press the MENU button and the ON-SCREEN MENU will appear. Press POINT LEFT/RIGHT button to move the red frame to the INPUT Menu icon.
- 2 Press the POINT DOWN button to move the red arrow to Computer and then press the SET button.

INPUT MENU

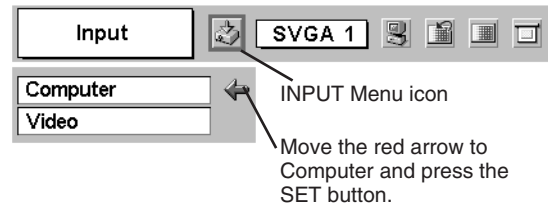

SELECTING THE COMPUTER SYSTEM

This projector automatically tunes to most different types of computers based on VGA, SVGA, XGA or SXGA (refer to "COMPATIBLE COMPUTER SPECIFICATION" on page 23). When selecting Computer, this projector automatically tunes to incoming signal and projects proper image without any special setting. (Some computers need to be set manually.)

Note : Projector may display one of the following messages.

Auto

When the projector cannot recognize the connected signal, the Auto PC Adjustment function adjusts the projector and the message "Auto" is displayed on the SYSTEM Menu icon. (Refer to P24.) When the image is not displayed properly, manual adjustment is required. (Refer to P25 and 26.)



There is no signal input from the computer. Make sure the connection between the computer and the projector are set correctly. (Refer to TROUBLESHOOTING on page 40.)

PC SYSTEM MENU

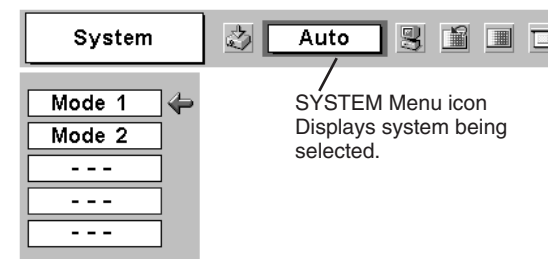

SELECT THE COMPUTER SYSTEM MANUALLY

This projector automatically selects the PC system among those provided in this projector and PC system can be also selected manually.

- 1 Press the MENU button and the ON-SCREEN MENU will appear. Press the POINT LEFT/RIGHT buttons to move the red frame to PC SYSTEM Menu icon.
- 2 Press the POINT DOWN button to move the red arrow to the system that you want to set, and then press the SET button.

PC SYSTEM MENU

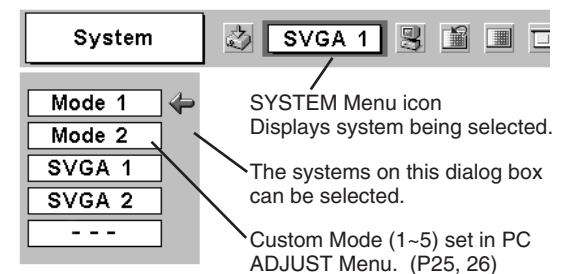

COMPATIBLE COMPUTER SPECIFICATIONS

This projector can accept the signal from all computers with the V, H-Frequency below mentioned and less than 100 MHz of Dot Clock.

ON-SCREEN DISPLAY	RESOLUTION	H-Freq. (kHz)	V-Freq. (Hz)	ON-SCREEN DISPLAY	RESOLUTION	H-Freq. (kHz)	V-Freq. (Hz)
VGA 1	640 x 480	31.47	59.88	XGA 3	1024 x 768	60.023	75.03
VGA 2	720 x 400	31.47	70.09	XGA 4	1024 x 768	56.476	70.07
VGA 3	640 x 400	31.47	70.09	XGA 5	1024 x 768	60.31	74.92
VGA 4	640 x 480	37.86	74.38	XGA 6	1024 x 768	48.50	60.02
VGA 5	640 x 480	37.86	72.81	XGA 7	1024 x 768	44.00	54.58
VGA 6	640 x 480	37.50	75.00	XGA 8	1024 x 768	63.48	79.35
VGA 7	640 x 480	43.269	85.00	XGA 9	1024 x 768	36.00	87.17 (Interlace)
MAC LC13	640 x 480	34.97	66.60	XGA 10	1024 x 768	62.04	77.07
MAC 13	640 x 480	35.00	66.67	XGA 11	1024 x 768	61.00	75.70
RGB	————	15.625	50 (Interlace)	XGA 12	1024 x 768	35.522	86.96 (Interlace)
RGB	————	15.734	60 (Interlace)	XGA 13	1024 x 768	46.90	58.20
SVGA 1	800 x 600	35.156	56.25	XGA 14	1024 x 768	47.00	58.30
SVGA 2	800 x 600	37.88	60.32	XGA 15	1024 x 768	58.03	72.00
SVGA 3	800 x 600	46.875	75.00	MAC 19	1024 x 768	60.24	75.08
SVGA 4	800 x 600	53.674	85.06	MAC 21	1152 x 870	68.68	75.06
SVGA 5	800 x 600	48.08	72.19	SXGA 1	1152 x 864	64.20	70.40
SVGA 6	800 x 600	37.90	61.03	SXGA 11	1152 x 900	61.20	65.20
SVGA 7	800 x 600	34.50	55.38	SXGA 13	1280 x 1024	50.00	86.00 (Interlace)
SVGA 8	800 x 600	38.00	60.51	SXGA 14	1280 x 1024	50.00	94.00 (Interlace)
SVGA 9	800 x 600	38.60	60.31	SXGA 17	1152 x 900	61.85	66.00
SVGA 10	800 x 600	32.70	51.09	SXGA 18	1280 x 1024	46.43	86.70 (Interlace)
SVGA 11	800 x 600	38.00	60.51	720p (HDTV)	————	45.00	60.00
MAC 16	832 x 624	49.72	74.55	1035i (HDTV)	————	33.75	60.00 (Interlace)
XGA 1	1024 x 768	48.36	60.00	1080i60 (HDTV)	————	33.75	60.00 (Interlace)
XGA 2	1024 x 768	68.677	84.997	1080i50 (HDTV)	————	28.125	50.00 (Interlace)

NOTE : Specifications are subject to change without notice.

PC ADJUSTMENT

AUTO PC ADJUSTMENT

The Auto PC Adjustment function is provided to automatically adjust Fine sync, Total dots and Picture Position to conform to your computer. Auto PC Adjustment function can be operated as follows.

 **Auto PC Adj.**

- 1 Press the MENU button and the ON-SCREEN MENU will appear. Press POINT LEFT/RIGHT button to move the red frame to PC ADJUST Menu icon.
- 2 Press the POINT DOWN button to move the red frame to the AUTO PC Adj. icon and then press the SET button twice. This Auto PC Adjustment can be also executed by pressing the AUTO PC ADJ. button on the Remote Control Unit.

Store adjustment parameters.

Adjustment parameters from Auto PC Adjustment can be memorized in this projector. Once parameters are memorized, setting can be done just by selecting Mode in PC SYSTEM Menu (P22). Refer to step 3 of MANUAL PC ADJUSTMENT section (P26).

NOTE

- Fine sync, Total dots and Picture Position of some computers can not be fully adjusted with this Auto PC Adjustment function. When the image is not provided properly through this function, manual adjustments are required. (Refer to page 25, 26.)
- Auto PC Adjustment function cannot be operated when “RGB,” “720p (HDTV),” “1035i (HDTV)” or “1080i (HDTV)” is selected on PC SYSTEM Menu (P22).

PC ADJUST MENU

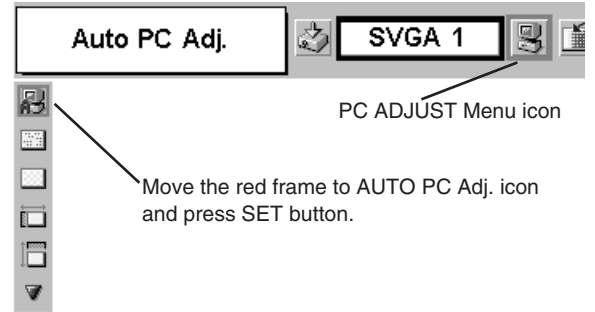

MANUAL PC ADJUSTMENT

This projector can automatically tune to the display signals of most personal computers. However, some computers employ special signal formats which are different from the standard ones and may not be tuned by the Multi-Scan system of this projector. If this happens, projector cannot reproduce a proper image and the image may be displayed as a flickering picture, a non-synchronized picture, a non-centered picture or a skewed picture.

This projector has Manual PC Adjustment to enable you to precisely adjust several parameters to match those special signal formats. This projector has 5 independent memory areas to memorize those parameters manually adjusted. This enables you to recall the setting for a specific computer whenever you use it.

Note : This PC ADJUST Menu cannot be operated when "RGB" is selected on PC SYSTEM Menu (P22).

- 1 Press the MENU button and the ON-SCREEN MENU will appear. Press the POINT LEFT/RIGHT button to move the red frame to PC ADJUST Menu icon.
- 2 Press the POINT DOWN button to move the red frame to the item that you want to adjust and then press the SET button. The Adjustment dialog box will appear. Press the POINT LEFT/RIGHT button to adjust value.

Fine sync

Adjusts an image as necessary to eliminate flicker from the display. Press the POINT LEFT/RIGHT button to adjust value.(From 0 to 31.)

Total dots

The number of total horizontal dots in your picture. Press the POINT LEFT/RIGHT button(s) and adjust number to match your PC image.

Horizontal

Adjusts the horizontal picture position. Press the POINT LEFT/RIGHT button(s) to adjust the position.

Vertical

Adjusts the vertical picture position. Press the POINT LEFT/RIGHT button(s) to adjust the position.

Current mode

Press the SET button to show the information of the computer selected.

Clamp

Adjusts the clamp level. When the image has a dark bar(s), try this adjustment.

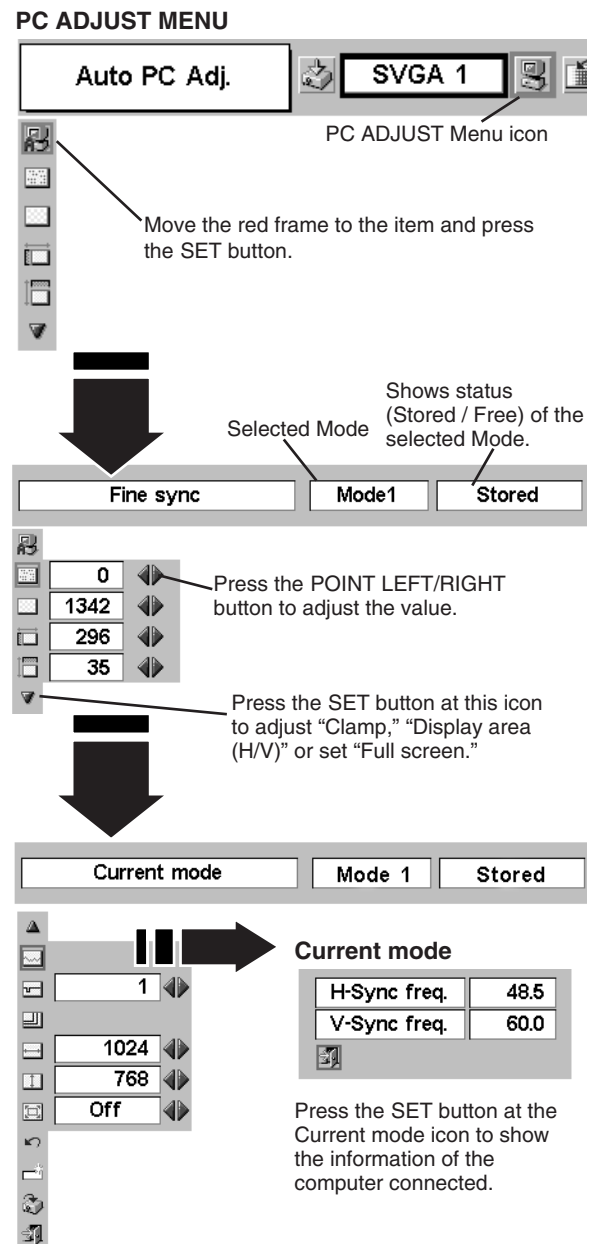

PC ADJUST MENU

Auto PC Adj. **SVGA 1**

PC ADJUST Menu icon

Move the red frame to the item and press the SET button.

Shows status (Stored / Free) of the selected Mode.

Selected Mode **Mode1** **Stored**

Fine sync

0 **1342** **296** **35**

Press the POINT LEFT/RIGHT button to adjust the value.

Press the SET button at this icon to adjust "Clamp," "Display area (H/V)" or set "Full screen."

Current mode **Mode 1** **Stored**

Current mode

H-Sync freq.	48.5
V-Sync freq.	60.0

Press the SET button at the Current mode icon to show the information of the computer connected.

Display area

Selects the area displayed with this projector. Select the resolution at the Display area dialog box.

Display area H

Adjustment of horizontal area displayed with this projector. Press the POINT LEFT/RIGHT button(s) to decrease/increase value to match the resolution of image.

Display area V

Adjustment of vertical area displayed with this projector. Press the POINT LEFT/RIGHT button(s) to decrease/increase value to match the resolution of image.

Full screen

Press the POINT LEFT/RIGHT button(s) to switch Full screen function to "On" or "Off." Set "On" to resize the image with 4 x 3 aspect ratio to fit the screen.

NOTE : Display area (H/V) and Full screen cannot be adjusted when "1035i (HDTV)" or "1080i (HDTV)" is selected on PC SYSTEM Menu (P22).

3 Store

To store adjustment parameters, move the red frame to the Store icon and then press the SET button. Move the red arrow to any of Mode 1 to 5 that you want to store and then press the SET button.

Mode free

To clear the adjustment parameters previously set, move the red frame to Mode free icon and then press the SET button. Move the red arrow to the Mode that you want to clear and then press the SET button.

Other icons operate as follows.

Reset

Reset all adjustment parameters on the adjustment dialog box to the previous figure.

Quit

Closes PC ADJUST MENU.

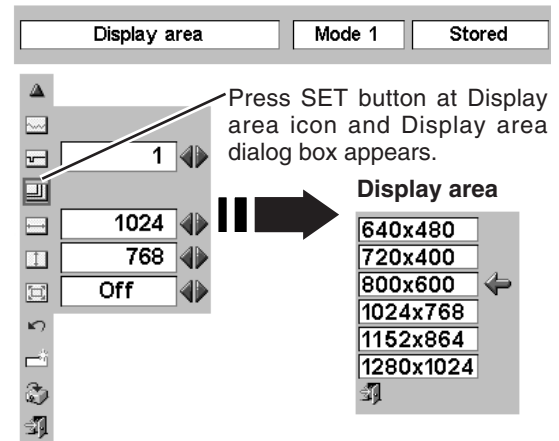

Press SET button at Display area icon and Display area dialog box appears.

To store the adjustment data.

This Mode has parameters being stored.

Where to reserve ?

Mode	Stored	1346	301	39	1024	768
Mode 1	Stored	1346	301	39	1024	768
Mode 2	Free	1346	216	35	1024	768
Mode 3	Free	1346	216	35	1024	768
Mode 4	Free	1346	216	35	1024	768
Mode 5	Free	1346	216	35	1024	768

Vacant Mode

Shows values of "Total dots," "Horizontal," "Vertical," "Display area H," and "Display area V."

To clear the adjustment data.

Which mode to free ?

Mode	Stored	1346	301	39	1024	768
Mode 1	Stored	1346	301	39	1024	768
Mode 2	Free	1346	216	35	1024	768
Mode 3	Free	1346	216	35	1024	768
Mode 4	Free	1346	216	35	1024	768
Mode 5	Free	1346	216	35	1024	768

Close this dialog box.

PICTURE IMAGE ADJUSTMENT

IMAGE LEVEL SELECT (DIRECT)

Select the image level among Standard, High contrast and Custom by pressing the IMAGE button on the Remote Control Unit.

Standard

Normal picture adjustment preset on this projector.

High contrast

Picture adjustment improved in reproduction of halftones. This adjustment is suitable for providing better image in brighter place.

Custom

User preset picture adjustment in the IMAGE ADJUST Menu (P28, 29).

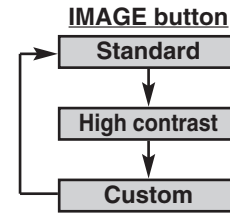

IMAGE LEVEL SELECT (MENU)

- 1 Press the MENU button and the ON-SCREEN MENU will appear. Press the POINT LEFT/RIGHT button to move the red frame to the IMAGE SELECT Menu icon.
- 2 Press the POINT DOWN button to move the red frame to the level that you want to set and then press the SET button.



Standard

Normal picture adjustment preset on this projector.



High contrast

Picture adjustment improved in reproduction of halftones. This adjustment is suitable for providing better image in brighter place.



Custom

User preset picture adjustment in the IMAGE ADJUST Menu (P28, 29).

IMAGE SELECT MENU

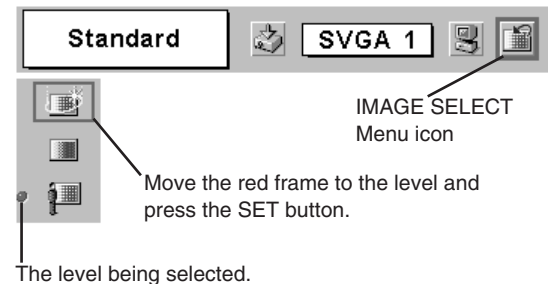

IMAGE LEVEL ADJUSTMENT

- 1 Press the MENU button and the ON-SCREEN MENU will appear. Press the POINT LEFT/RIGHT buttons to move the red frame to the IMAGE ADJUST Menu icon.
- 2 Press the POINT DOWN button to move the red frame to the item that you want to adjust. and then press the SET button. The level of each item is displayed. Adjust each level by the pressing the POINT LEFT/RIGHT button(s).

Contrast

Press the POINT LEFT button to decrease contrast, and the POINT RIGHT button to increase contrast. (From 0 to 63.)

Brightness

Press the POINT LEFT button to adjust image darker, and the POINT RIGHT button to adjust brighter. (From 0 to 63.)

Color

Press the POINT LEFT button to lighten color, and the POINT RIGHT button to darker color. (From 0 to 63.)

Tint

Press the POINT LEFT button or the POINT RIGHT button to obtain proper color. (From 0 to 63.)

White balance (Red)

Press the POINT LEFT button to lighten red tone and the POINT RIGHT button to darker tone. (From 0 to 63.)

White balance (Green)

Press the POINT LEFT button to lighten green tone and the POINT RIGHT button to darker tone. (From 0 to 63.)

White balance (Blue)

Press the POINT LEFT button to lighten blue tone and the POINT RIGHT button to darker tone. (From 0 to 63.)

Sharpness

Press the POINT LEFT button to soften the image, and the POINT RIGHT button to sharpen the image. (From 0 to 15.)

Gamma

Press either the POINT LEFT button or the POINT RIGHT button to obtain better balance of contrast. (From 0 to 15.)

Auto grayscale

When this function is "ON", it automatically enhances the contrast of the bright and dark part of image.

Auto fleshtone

When this function is "ON", it automatically produces a more vivid image according to the image condition.

IMAGE ADJUST MENU

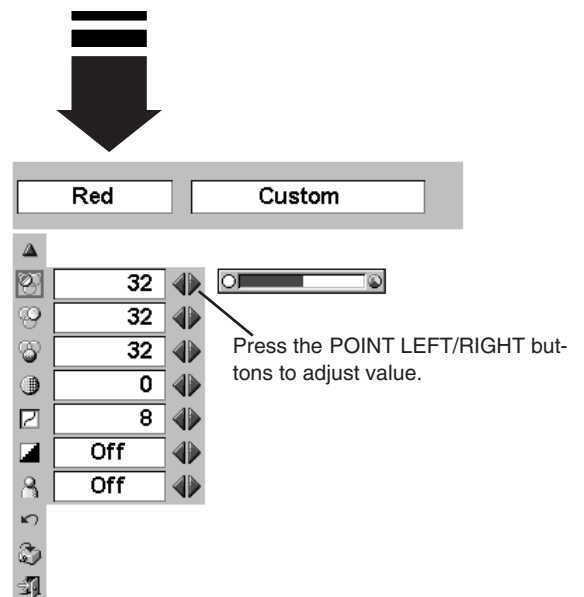
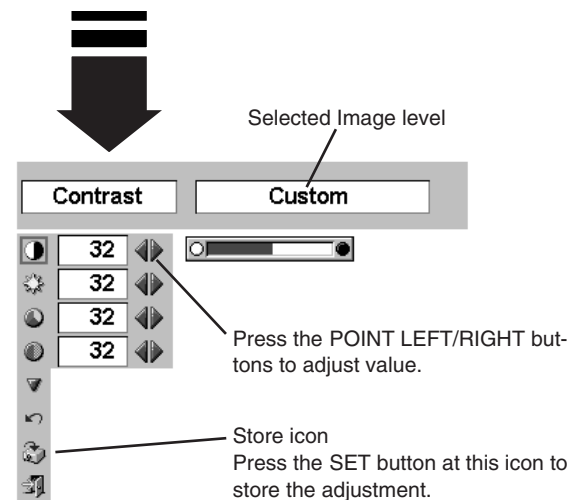
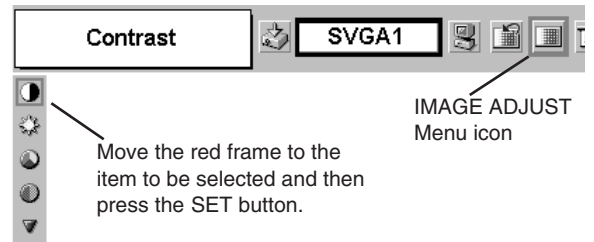

3  **Store**

To store the manually preset image level, move the red frame to the Store icon and press the SET button. The message "OK?" will appear. Select [Yes] to store the manual adjustment.

To set this manual adjustment, select the Custom by pressing the IMAGE button or through the IMAGE SELECT MENU (refer to P27).

Other icons operate as follows.

 **Reset**

Reset all adjustment to previous figure.

 **Quit**

Closes the IMAGE MENU.

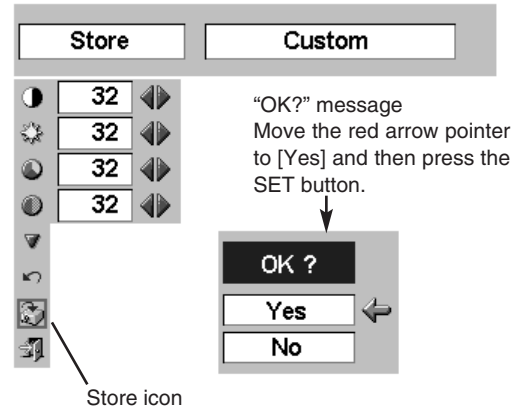

PICTURE SCREEN ADJUSTMENT

This projector has a picture screen resize function, which enables you to display the desirable image size.

1 Press the MENU button and the ON-SCREEN MENU will appear. Press the POINT LEFT/RIGHT button(s) to move the red frame to the SCREEN Menu icon.

2 Press the POINT DOWN button and move the red frame to the function that you want to select and then press the SET button.

SCREEN MENU

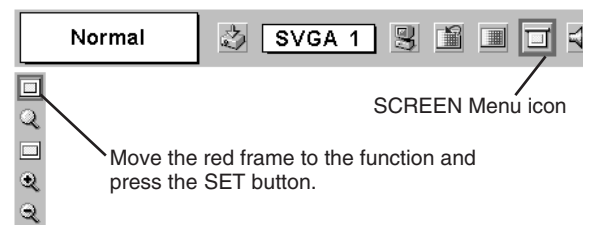

 **Normal**

Provides image to fit screen size.

 **True**

Provides image in its original size. When the original image size is larger than screen size (800 x 600), this projector enters "Digital zoom +" mode automatically.

 **Wide**

Provides an image to fit the wide video aspect ratio (16 : 9) by expanding image width uniformly. This function can be used for providing a squeezed video signal at 16 : 9.

 **Digital zoom +**

When Digital zoom + is selected, the ON-SCREEN MENU disappears and the message "D. Zoom +" is displayed. Press the SET button to expand image size. And press the POINT UP/DOWN/LEFT/RIGHT button(s) to pan the image. The panning function can work only when the image is larger than screen size.

A projected image can be also expanded by pressing D.ZOOM W (Wide) button on Remote Control Unit.

 **Digital zoom -**

When Digital zoom - is selected, the ON-SCREEN MENU disappears and the message "D. Zoom -" is displayed. Press the SET button to compress image size.

A projected image can be also compressed by pressing the D.ZOOM T (Tele) button on Remote Control Unit.

To cancel the Digital Zoom +/- mode, press any button except D.ZOOM W/T, SET, and POINT buttons.

NOTE

- This SCREEN Menu cannot be operated when "1035i (HDTV)" or "1080i (HDTV)" is selected on PC SYSTEM Menu (P22).
- Wide cannot be selected when "720p (HDTV)" is selected on PC SYSTEM Menu (P22).
- True and Digital zoom +/- cannot be selected when "RGB" is selected on PC SYSTEM Menu (P22).
- This projector cannot display any resolution higher than 1280 X 1024. If your computer's screen resolution is higher than 1280 X 1024, lower the resolution before connecting projector.
- Digital zoom - cannot be operated when the image resolution is SXGA (1280 x 1024).
- The image data in other than SVGA (800 x 600) is modified to fit the screen size.
- The panning function may not operate properly if the computer system set on PC ADJUST Menu is used.

SELECTING THE INPUT SOURCE

DIRECT OPERATION

Choose Video by pressing the INPUT button on the Top Control or on the Remote Control Unit.

If the projector cannot reproduce a proper video source, select correct input source through the MENU OPERATION (see below).

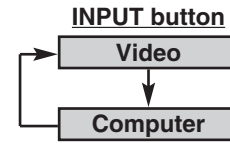

MENU OPERATION

- 1 Press the MENU button and the ON-SCREEN MENU will appear. Press the POINT LEFT/RIGHT button to move the red frame to the INPUT Menu icon.
- 2 Press the POINT DOWN button to move the red arrow to Video and then press the SET button. The Source Select Menu will appear.
- 3 Move the red arrow to the source that you want to select and then press the SET button.

Auto

The projector automatically detects incoming the Video signal, and adjusts itself to optimize its performance.

- When both VIDEO jack and S-VIDEO jack are connected, S-VIDEO jack has priority over VIDEO jack.
- When both Y-Pb/Cb-Pr/Cr jacks and S-VIDEO jack are connected, Y-Pb/Cb-Pr/Cr jacks have priority over S-VIDEO jack.

Video

When the video input signal is connected to VIDEO jack, select Video.

S-Video

When the video input signal is connected to S-VIDEO jack, select S-Video.

Y,Pb/Cb,Pr/Cr

When the video input signal is connected to Y-Pb/Cb-Pr/Cr jacks, select Y, Pb/Cb, Pr/Cr.

INPUT MENU

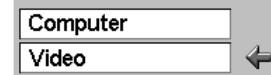

Move the red arrow to Video and press the SET button.

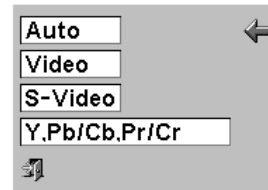

Source Select Menu (VIDEO)

Move the red arrow to the source and press the SET button.

SELECTING THE VIDEO SYSTEM

- 1 Press the MENU button and the ON-SCREEN MENU will appear. Press the POINT LEFT/RIGHT buttons to move the red frame to AV SYSTEM Menu icon.
- 2 Press the POINT DOWN button to move the red arrow to the system that you want to select and then press the SET button.

VIDEO JACK OR S-VIDEO JACK

Auto

Projector automatically detects the incoming Video system, and adjusts itself to optimize its performance.

When Video System is PAL-M or PAL-N, select system manually.

PAL / SECAM / NTSC / NTSC4.43 / PAL-M / PAL-N

If projector cannot reproduce a proper video image, it is necessary to select a specific broadcast signal format among PAL, SECAM, NTSC, NTSC 4.43, PAL-M, and PAL-N.

AV SYSTEM MENU (VIDEO OR S-VIDEO)

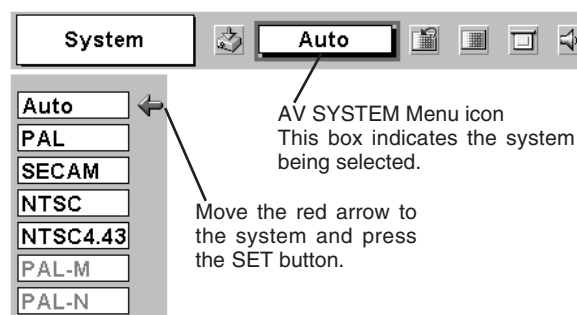

Y, Pb/Cb, Pr/Cr JACKS

Auto

The projector automatically detects the incoming Video signal, and then adjusts itself to optimize its performance.

COMPONENT VIDEO SIGNAL FORMAT

If the projector cannot reproduce a proper video image, it is necessary to select a specific component video signal format among 480i, 575i, 480p, 575p, 720p, 1035i and 1080i.

AV SYSTEM MENU (COMPONENT VIDEO)

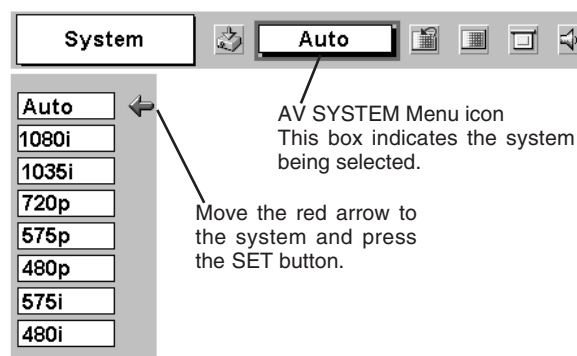

PICTURE IMAGE ADJUSTMENT

IMAGE LEVEL SELECT (DIRECT)

Select the image level among Standard, Cinema, and Custom by pressing the IMAGE button on Remote Control Unit.

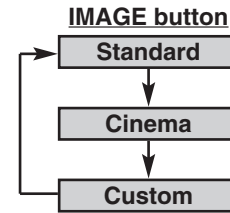

Standard

Normal picture adjustment preset on this projector.

Cinema

Picture level adjusted for the picture with fine tone.

Custom

User preset picture adjustment in IMAGE ADJUST Menu (P33,34).

IMAGE LEVEL SELECT (MENU)

- 1 Press the MENU button and the ON-SCREEN MENU will appear. Press the POINT LEFT/RIGHT button to move the red frame to the IMAGE SELECT Menu icon.
- 2 Press the POINT DOWN button to move the red frame to the level that you want to set and then press the SET button.

IMAGE SELECT MENU

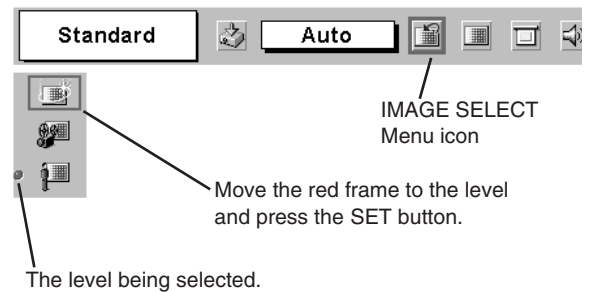

Standard

Normal picture adjustment preset on this projector.

Cinema

Picture level adjusted for the picture with fine tone.

Custom

User preset picture adjustment in IMAGE ADJUST Menu (P33, 34).

IMAGE LEVEL ADJUSTMENT

- 1 Press the MENU button and the ON-SCREEN MENU will appear. Press the POINT LEFT/RIGHT button(s) to move the red frame to the IMAGE ADJUST Menu icon.
- 2 Press the POINT DOWN button to move the red frame to the item that you want to adjust and then press the SET button. The level of each item is displayed. Adjust each level by pressing the POINT LEFT/RIGHT button(s).

Contrast

Press the POINT LEFT button to decrease contrast, and the POINT RIGHT button to increase contrast. (From 0 to 63.)

Brightness

Press the POINT LEFT button to adjust image darker, and the POINT RIGHT button to adjust brighter. (From 0 to 63.)

Color

Press the POINT LEFT button to lighten color, and the POINT RIGHT button to darker color. (From 0 to 63.)

Tint

Press the POINT LEFT button or the POINT RIGHT button to obtain the proper color. (From 0 to 63.)

White balance (Red)

Press the POINT LEFT button to lighten the red tone and the POINT RIGHT button to darker tone. (From 0 to 63.)

White balance (Green)

Press the POINT LEFT button to lighten the green tone and the POINT RIGHT button to darker tone. (From 0 to 63.)

White balance (Blue)

Press the POINT LEFT button to lighten the blue tone and the POINT RIGHT button to darker tone. (From 0 to 63.)

Sharpness

Press the POINT LEFT button to soften the image, and the POINT RIGHT button to sharpen the image. (From 0 to 15.)

Gamma

Press either the POINT LEFT button or the POINT RIGHT button to obtain a better balance of contrast. (From 0 to 15.)

Auto grayscale

When this function is "ON", it automatically enhances the contrast of the bright and dark part of image.

Auto fleshtone

When this function is "ON", it produces a more vivid image according to the image condition.

IMAGE ADJUST MENU

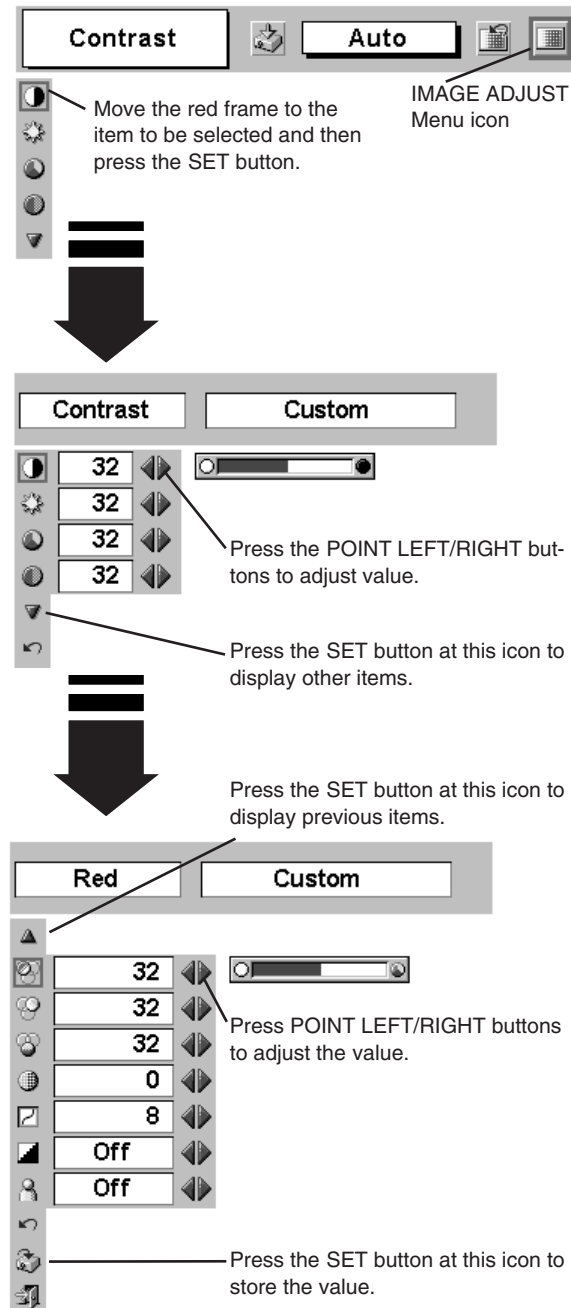

The diagram illustrates the navigation process through the IMAGE ADJUST MENU. It shows three stages of the menu:

- Stage 1:** The main menu with 'Contrast' and 'Auto' options. A red frame highlights the 'Contrast' option. An arrow points to the 'IMAGE ADJUST Menu icon' (a grid icon).
- Stage 2:** The 'Contrast' sub-menu is displayed, showing '32' for Contrast, Brightness, Color, and Tint. A red frame highlights the 'Contrast' option. An arrow points to the 'SET' button icon.
- Stage 3:** The 'Red' sub-menu is displayed, showing '32' for White balance (Red), '32' for White balance (Green), '32' for White balance (Blue), '0' for Sharpness, '8' for Gamma, and 'Off' for Auto grayscale and Auto fleshtone. A red frame highlights the 'Red' option. An arrow points to the 'SET' button icon.

Annotations and instructions:

- Move the red frame to the item to be selected and then press the SET button.
- Press the POINT LEFT/RIGHT buttons to adjust value.
- Press the SET button at this icon to display other items.
- Press the SET button at this icon to display previous items.
- Press the SET button at this icon to store the value.

NOTE : Tint cannot be adjusted when the video system is PAL, SECAM, PAL-M or PAL-N.

3 Store

To store a manually preset image level, move the red frame to the Store icon and press the SET button. The message “OK?” will appear. Select [Yes] to store the manual adjustment. To set this manual adjustment, select Custom by pressing the IMAGE button or through the IMAGE SELECT MENU (refer to P32).

Other icons operate as follows.

Reset

Reset all adjustment to the previous figure.

Quit

Closes the IMAGE MENU.

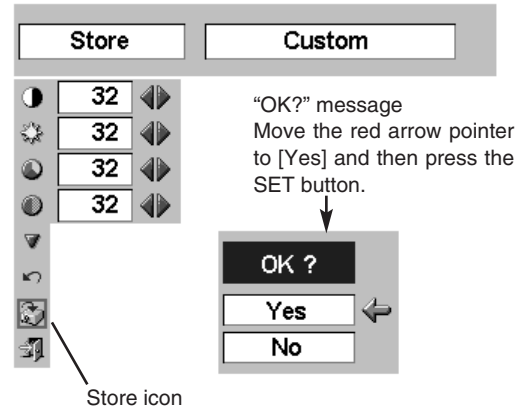

PICTURE SCREEN ADJUSTMENT

This projector has a picture screen resize function, which enables you to display the desirable image size.

- 1 Press the MENU button and the ON-SCREEN MENU will appear. Press the POINT LEFT/RIGHT button(s) to move the red frame to the SCREEN Menu icon.
- 2 Press the POINT DOWN button and move the red frame to the function that you want to select and then press the SET button.

SCREEN MENU

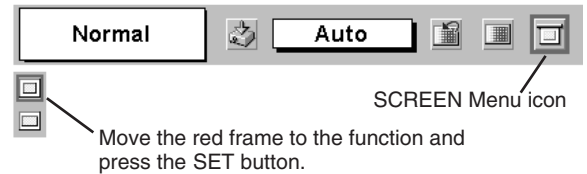

Normal

Provides image at a normal video aspect ratio of 4 : 3.

Wide

Provides image at a wide screen ratio of 16 : 9.

NOTE : The SCREEN Menu cannot be operated when “720p,” “1035i,” or “1080i” is selected on the AV SYSTEM Menu (P31).

SETTING MENU

- 1 Press the MENU button and the ON-SCREEN MENU will appear. Press the POINT LEFT/RIGHT button(s) to move the red frame to the SETTING icon.
- 2 Press the POINT DOWN button to move the red frame to the item that you want to set and then press the SET button. The Setting dialog box appears.

SETTING MENU

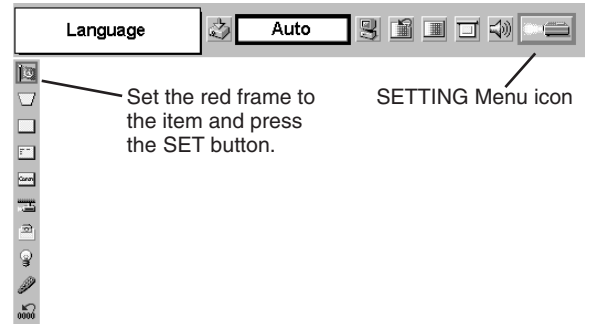

Language

The Language used in the ON-SCREEN MENU is selectable from English, German, French, Italian, Spanish, Portuguese, Dutch, Swedish, Chinese, Korean, and Japanese.

Keystone

When the image is distorted vertically, select Keystone. The ON-SCREEN MENU disappears and the Keystone dialog box is displayed. Correct the keystone distortion by pressing the POINT UP/DOWN button(s). Refer to KEYSTONE ADJUSTMENT on page 20.

Blue back

When this function is "On," the projector produces a blue image while the input signal is not detected.

Display

This function decides whether to display the On-Screen Displays.

- On ... shows all the On-Screen Displays.
- Off ... sets On-Screen Displays disappeared except;
 - ON-SCREEN MENU
 - "Power off?" message (P19)
 - P-TIMER
 - "No signal" message (P36)
 - "Wait a moment!" message

Logo

When this function is "On," the projector displays the Canon logo when starting up.

Ceiling

When this function is "On," the picture is top / bottom and left / right reversed. This function is used to project the image from a ceiling mounted projector.

Rear

When this function is "On," picture is left / right reversed. This function is used to project the image to a rear projection screen.

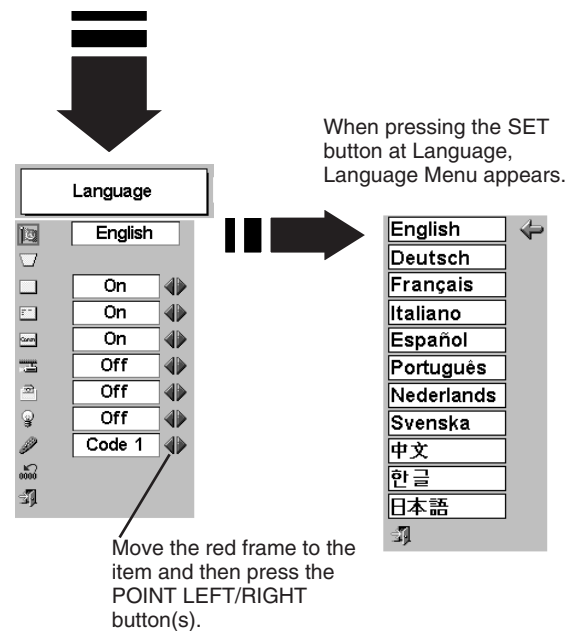

Ceiling function

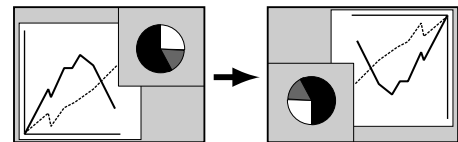

Rear function

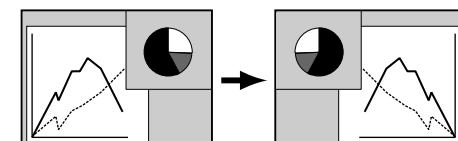



Power management

This function turns the Projection Lamp off when this projector detects signal interruption and is not used for a certain period in order to reduce power consumption and maintain the Lamp-life. (This projector is shipped with this function ON.)

Power Management function operates to turn the Projection Lamp off when the input signal is interrupted and any button is not pressed over 5 minutes. This function operates as follows;

1. When any input signal is interrupted, "No signal" and the count down display appears (for 5 minutes).
2. After counting down for 5 minutes, the Projection Lamp and the READY Indicator are turned off. (Cooling Fans keep running.)
3. The READY Indicator starts to flash after cooling down the Projection Lamp about for 90 seconds (Power Management mode).

In this Power Management mode, the Projection Lamp is automatically turned on when the input signal is connected or the projector is operated with any button on the Top Control or on the Remote Control Unit again.



Time left until Lamp off.



Remote control

This projector has two different remote control codes; the factory-set normal code (Code 1) and the secondary code (Code 2). This switching function prevents remote control interference when operating several projectors or video equipment together.

When operating projector in "Code 2," both projector and Remote Control Unit must be switched to "Code 2."

To change the code of Projector:

Set the Remote control in the SETTING MENU to "Code 2."

To change the code of the Remote Control Unit:

Press both the MENU and the IMAGE buttons on the Remote Control Unit together for over 10 seconds.

After changing the code, make sure the Remote Control Unit operates properly.

To return to the normal code (Code 1), repeat the steps above.

NOTE : When the battery of Remote Control Unit is replaced, the remote control code automatically returns to the normal code (Code 1).



Lamp counter reset

This function is used to reset the Lamp Replace Counter. When replacing the Projection Lamp, reset the Lamp Replace Counter by using this function. Refer to page 38 for operation.

LAMP REPLACEMENT

LAMP REPLACE

When the life of the Projection Lamp of this projector draws to an end, the LAMP REPLACE indicator lights yellow. If this indicator lights yellow, replace the projection lamp with a new one promptly.

TOP CONTROL

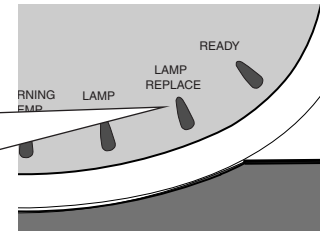

This indicator lights yellow when the life of the projection lamp draws to an end. Replace the Projection Lamp with a new one promptly.



Allow the projector to cool, for at least 45 minutes before you open the Lamp Cover. The inside of a projector can become very hot.



CAUTION

For continued safety, replace with a lamp assembly of the same type.

Do not drop the lamp assembly or touch the glass bulb! The glass can shatter and may cause injury.

Follow these steps to replace the lamp assembly.

- 1** Turn off the projector and disconnect the AC plug. Allow the projector to cool at least for 45 minutes.
- 2** To remove the Lamp Cover, remove the screw with a screwdriver.
- 3** Remove the 2 screws with a screwdriver and pull out Lamp Assembly by grasping Handle.
- 4** Replace the Lamp Assembly with a new one and tighten 2 screws back into position. Make sure that the Lamp Assembly is set properly. Replace Lamp Cover and tighten the screw.
- 5** Connect the AC Power Cord to the projector and turn on the projector.
- 6** **Reset the Lamp Replace Counter.**
Refer to "LAMP REPLACE COUNTER" on the next page.

NOTE : Do not reset the Lamp Replace Counter when Projection Lamp is not replaced.

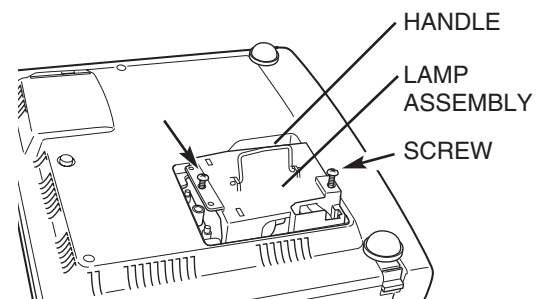
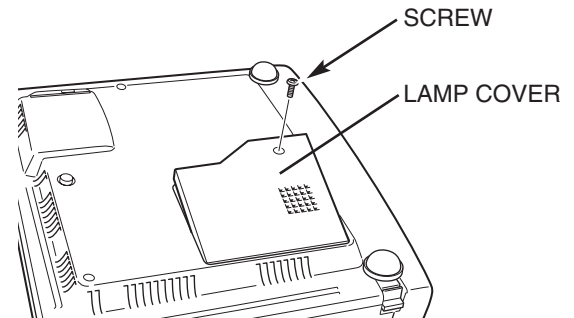

ORDER REPLACEMENT LAMP

The Replacement Lamp can be ordered through your dealer. When ordering a Projection Lamp, give the following information to the dealer.

- **Model No. of your projector** : **LV-S2**
- **Replacement Lamp Type No.** : **LV-LP14**

(Service Parts No. 610 295 5712)

LAMP REPLACE COUNTER

Be sure to reset the Lamp Replace Counter after the Lamp Assembly is replaced. When the Lamp Replace Counter is reset, the LAMP REPLACE Indicator stops lighting.

- 1 Turn the projector on, press the MENU button and the ON-SCREEN MENU will appear. Press the POINT LEFT/RIGHT button(s) to move the red frame to the SETTING Menu icon (refer to page 35, 36).
- 2 Press the POINT DOWN button to move the red frame to "Lamp counter reset" and then press the SET button. The message "Lamp replace counter reset?" is displayed. Move the red arrow to [Yes] and then press the SET button.
- 3 Another confirmation dialog box appears and select [Yes] to reset the Lamp Replace Counter.

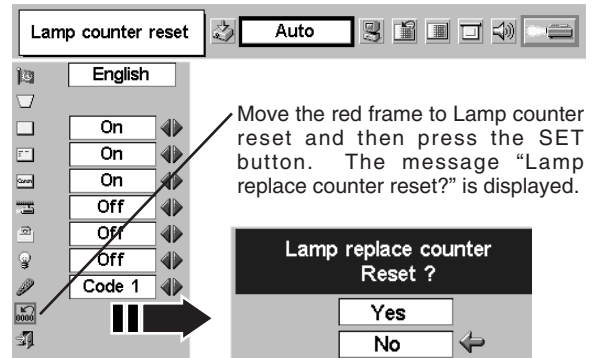

NOTE : Do not reset the Lamp Replace Counter until after the Projection Lamp is replaced.



LAMP HANDLING PRECAUTIONS

This projector uses a high-pressure lamp which must be handled carefully and properly. Improper handling may result in accidents, injury, or create a fire hazard.

- Lamp lifetime may differ from lamp to lamp and according to the environment of use. There is no guarantee of the same lifetime for each lamp. Some lamps may fail or terminate their lifetime in a shorter period of time than other similar lamps.
- If the projector indicates that the lamp should be replaced, i.e., if the LAMP REPLACE INDICATOR lights up, replace the lamp with a new one IMMEDIATELY after the projector has cooled down. (Follow carefully the instructions in the LAMP REPLACEMENT section of this manual.) Continuous use of the lamp with the LAMP REPLACE INDICATOR lighted may increase the risk of lamp explosion.
- A Lamp may explode as a result of vibration, shock or degradation as a result of hours of use as its lifetime draws to an end. Risk of explosion may differ according to the environment or conditions in which the projector and lamp are being used.

IF A LAMP EXPLODES, THE FOLLOWING SAFETY PRECAUTIONS SHOULD BE TAKEN.

If a lamp explodes, disconnect the projector's AC plug from the AC outlet immediately. Contact an authorized service station for a checkup of the unit and replacement of the lamp. Additionally, check carefully to ensure that there are no broken shards or pieces of glass around the projector or coming out from the cooling air circulation holes. Any broken shards found should be cleaned up carefully. No one should check the inside of the projector except those who are authorized trained technicians and who are familiar with projector service. Inappropriate attempts to service the unit by anyone, especially those who are not appropriately trained to do so, may result in an accident or injury caused by pieces of broken glass.

MAINTENANCE

WARNING TEMP. INDICATOR

The WARNING TEMP. Indicator flashes red when the internal temperature of the projector exceeds the normal temperature. This Indicator stops flashing when the temperature of the projector returns to normal. When the WARNING TEMP. Indicator continues to flash, check the items listed below.

- 1 The Ventilation Slots of the projector may be blocked. In such an event, reposition the projector so that the Ventilation Slots are not obstructed.
- 2 The Air Filter may be clogged with dust particles. Clean the Air Filter by following section AIR FILTER CARE AND CLEANING below.
- 3 If the WARNING TEMP. Indicator remains on after performing the above checks, the Cooling Fans or the Internal Circuits may be malfunctioning. Contact service personnel from an authorized dealer or a service station.

AIR FILTER CARE AND CLEANING

The Removable Air Filter prevents dust from accumulating on the surface of the Projection Lens and the Projection Mirror. Should the Air Filter become clogged with dust particles, it will reduce Cooling Fans' effectiveness and may result in internal heat build up and adversely affect the life of the projector. Clean Air Filter following the steps below:

- 1 Turn off the projector, and disconnect the AC power cord from the AC outlet.
- 2 Turn the projector upside down and remove the two Air Filters (Large and Small) by pulling the latches upward.
- 3 Clean the Air Filters with a brush or wash out dust and particles.
- 4 Replace each Air Filter properly. Make sure that the Air Filters are fully inserted.



CAUTION

Do not operate the projector with the Air Filter removed. Dust may accumulate on the LCD Panel and the Projection Mirror, therefore degrading picture quality. Do not put small parts into Air Intake Vents. It may result in malfunction of the projector.

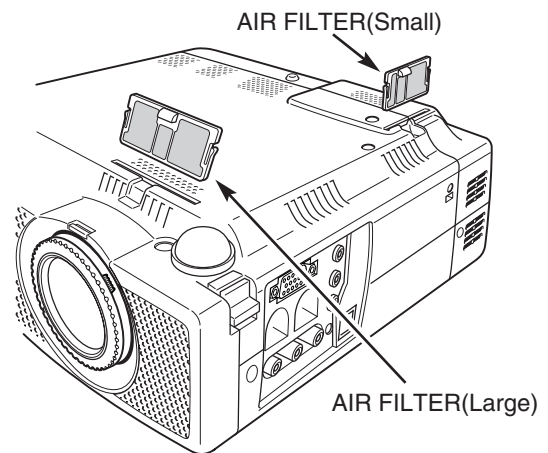

RECOMMENDATION

We recommend avoiding dusty/smoky environment when operating a projector. Usage in these environments may cause poor image quality.

When using under dusty or smoky conditions, dust may accumulate on the lens, liquid crystal panels, or optical elements inside the projector. This condition may degrade the quality of a projected image.

When the above symptoms are noticed, contact your authorized dealer or service station for proper cleaning.

CLEANING PROJECTION LENS

Follow these steps to clean the Projection Lens:

- 1 Apply a non-abrasive camera lens cleaner to a soft, dry cleaning cloth. Avoid using an excessive amount of cleaner. Abrasive cleaners, solvents or other harsh chemicals might scratch the lens.
- 2 Lightly wipe a cleaning cloth over Projection Lens.
- 3 When the projector is not in use, attach Lens Cover.

TROUBLESHOOTING

Before calling your dealer or service center for assistance, check the following:

1. Make sure you have connected a projector to your computer or video equipment as described in the section "CONNECTING THE PROJECTOR" on pages 11 ~ 13.
2. Check cable connection. Verify that all computer, video and power cord are properly connected.
3. Verify that all power is switched on.
4. If a projector still does not produce an image, re-start your computer.
5. If an image still does not appear, unplug the projector from your computer and check your computer monitor's display. The problem may be with your graphics controller rather than with the projector. (When you reconnect the projector, be sure to turn the computer and monitor off before you power up the projector. Turn the projector on, and then the computer.)
6. If the problem still exists, check the following chart.

Problem:	Try these Solutions
No power.	<ul style="list-style-type: none"> ● Plug the projector into your AC outlet. ● Make sure the READY Indicator lights. ● Wait 90 seconds after a projector is turned OFF before turning the projector back on. <p>NOTE : After pressing the Power ON-OFF button to OFF, make sure the projector works as follows:</p> <ol style="list-style-type: none"> 1. LAMP indicator lights bright and READY indicator turns off. 2. After 90 seconds, the READY indicator lights green again and the projector may be turned on by pressing the Power ON-OFF button. <ul style="list-style-type: none"> ● Check WARNING TEMP. indicator. If the indicator flashes red, the projector cannot be turned on. (See "TURNING ON/OFF PROJECTOR" section on page 19.) ● Check Projection Lamp. (Refer to page 37.)
Image is out of focus.	<ul style="list-style-type: none"> ● Adjust focus of the projector. ● Make sure the projection screen is at least 3.6' (1.1m) from the projector. ● Check Projection Lens to see if it needs cleaning. <p>NOTE : Moving a projector from a cool temperature location to a warm temperature location may result in moisture condensation on the Projection Lens. In such an event, leave the projector OFF and wait until condensation disappears.</p>
Picture is Left/Right reversed.	<ul style="list-style-type: none"> ● Check Ceiling / Rear feature. (See "SETTING" section on page 35.)
Picture is Top/Bottom reversed.	<ul style="list-style-type: none"> ● Check Ceiling feature. (See "SETTING" section on page 35.)
Some displays are not seen during the Operation.	<ul style="list-style-type: none"> ● Check Display feature.(See "SETTING" section on page 35.)
No image.	<ul style="list-style-type: none"> ● Check the connection between your computer or video equipment and the projector. ● Check the NO SHOW function. (Refer to page 21.) ● When turning the projector on, it takes about 30 seconds to display an image. ● Check the system that you select is corresponding with your computer or video equipment. ● Make sure the temperature is not out of the Operating Temperature (5°C ~ 35°C).
No sound.	<ul style="list-style-type: none"> ● Check audio cable connection from the audio input source. ● Adjust the audio source. ● Press the VOLUME (+) button. ● Press the MUTE button.

Problem:	Try these Solutions
Remote Control Unit does not work.	<ul style="list-style-type: none">● Check the battery.● Make sure nothing is between the Infrared Remote Receiver and the Remote Control Unit.● Observe maximum operating distance 16.4' (5m) between the receiver on the projector and the Remote Control Unit.● Make sure the code of the Remote Control Unit is set to conform to the projector. (See "SETTING" section on page 35, 36.)

WARNING :
High voltages are used to operate this projector. Do not attempt to open the cabinet.

If the problem still persists after following all operating instructions, contact the sales dealer where you purchased the projector or the service center. Give the model number and explain the problem in detail. We will advise you of how to obtain service.



This symbol on the nameplate means the product is Listed by Underwriters Laboratories Inc. It is designed and manufactured to meet rigid U.L. safety standards against risk of fire, casualty and electrical hazards.



The CE Mark is a Directive conformity mark of the European Community. (EC)

TECHNICAL SPECIFICATIONS

Projector Type	Multi-media Projector
Dimensions (W x H x D)	10.24" x 2.99" x 9.63" (260mm x 76mm x 244.5mm) (not including Adjustable Feet)
Net Weight	6.39lbs (2.9 kg)
LCD Panel System	0.7" TFT Active Matrix type, 3 panels
Panel Resolution	800 x 600 dots
Number of Pixels	1,440,000 (800 x 600 x 3 panels)
Color System	PAL, SECAM, NTSC, NTSC4.43, PAL-M and PAL-N
High Definition TV Signal	480i, 480p, 575i, 575p, 720p, 1035i, and 1080i
Scanning Frequency	H-sync. 15 ~ 80 KHz, V-sync. 50 ~ 100 Hz
Projection Image size (Diagonal)	Adjustable from 29" to 200"
Horizontal Resolution	500 TV lines (S-Video)
Projection Lens	F 1.6 ~ 2.0 lens with f 20.3 mm ~ 28.2 mm with manual zoom and focus
Throw Distance	3.6' ~ 26.2' (1.1 m ~ 8 m)
Projection Lamp	150 W
Video Input Jacks	RCA Type x 3 (Video/Y, Pb/Cb, Pr/Cr) and Mini DIN 4 pin x 1 (S-Video)
Audio Input Jacks	Mini Jack (stereo) x 1
Computer Input Terminals	(VGA) HDB 15 Terminal x 1
Computer Audio Input Jack	Mini Jack (stereo) x 1
Control Port Connector	Mini DIN 8 pin x 1
USB Connector	USB Series B receptacle x 1
Audio Output Jacks	Mini Jack (stereo) x 1
Internal Audio Amp	1.0 W RMS
Built-in Speaker	1 speaker, 1.4" x 0.8" (35mm x 20mm)
Feet Adjustment	0° to 10.7°
Voltage and Power Consumption	AC 100 ~ 120 V (2.5 A Max. Ampere), 50 / 60 Hz (The U.S.A and Canada) AC 200 ~ 240 V (1.4 A Max. Ampere), 50 / 60 Hz (Continental Europe)
Operating Temperature	41 °F ~ 95 °F (5 °C ~ 35 °C)
Storage Temperature	14 °F ~ 140 °F (-10 °C ~ 60 °C)
Remote Control Unit	Power Source : Lithium Type (CR2025 / 3.0V) Operating Range : 16.4' (5m) / ±30° Dimensions : 2.1" x 0.28" x 5.3" (54mm x 7mm x 135mm) Net Weight : 1.27oz (36 g) (including battery)
Accessories	Owner's Manual AC Power Cord Remote Control Unit and Battery VGA Cable Carrying Bag Lens Cover

- The specifications are subject to change without notice.

OPTIONAL PARTS

The parts listed below are optionally supplied. When ordering those parts, give name and Type No. of it to the sales dealer.

- | | | | |
|---------------------------------|--------------------|------------------------------|-------------------|
| ● Wireless Remote Control Unit | Type No. : LV-RC01 | ● Control Cable for ADB Port | Type No.: LV-CA27 |
| ● Control Cable for PS/2Port | Type No. : LV-CA25 | ● MAC Adapter | Type No.: LV-AD02 |
| ● Control Cable for Serial Port | Type No.: LV-CA26 | ● Ceiling Mount Hanger | Type No.: LV-CL06 |

CONFIGURATIONS OF THE TERMINALS

COMPUTER INPUT TERMINAL (ANALOG)

Terminal : HDB15-PIN

Connect the display output terminal of the computer to this terminal with the VGA Cable (supplied). When connecting the Macintosh computer, MAC Adapter (not supplied) is required.

Pin Configuration

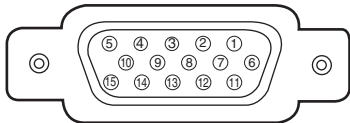

1	Red Input	9	No Connect
2	Green Input	10	Ground (Vert.sync.)
3	Blue Input	11	Sense 0
4	Sense 2	12	Sense 1
5	Ground (Horiz.sync.)	13	Horiz. sync.
6	Ground (Red)	14	Vert. sync.
7	Ground (Green)	15	Reserved
8	Ground (Blue)		

CONTROL PORT CONNECTOR

Terminal : Mini DIN 8-PIN

Connect control port (PS/2, Serial or ADB port) on your computer to this connector with Control Cable (not supplied).

Pin Configuration

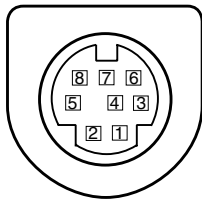

	PS/2	Serial	ADB
1	-----	R X D	-----
2	CLK	-----	ADB
3	DATA	-----	-----
4	GND	GND	GND
5	-----	RTS / CTS	-----
6	-----	T X D	-----
7	GND	GND	-----
8	-----	GND	GND

USB CONNECTOR (Series B)

Connect USB port terminal on your computer or peripheral equipment to this connector with USB Cable (not supplied).

Pin Configuration

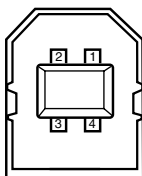

1	Vcc
2	- Data
3	+ Data
4	Ground



CANON INC. 30-2, Shimomaruko 3-chome, Ohta-ku, Tokyo 146-8501, Japan

CANON U.S.A., INC.

One Canon Plaza, Lake Success, NY 11042, U.S.A.

CANON CANADA, INC.

6390 Dixie Road Mississauga, Ontario L5T 1P7 Canada

CANON LATIN AMERICA, INC.

703 Waterford Way Suite 400 Miami, Florida 33126 U.S.A.

CANON EUROPA N.V.

P.O.Box 2262, 1180 EG Amstelveen, The Netherlands

CANON COMMUNICATION & IMAGE FRANCE S.A.

102, Avenue du General de Gaulle, 92250 La Garenne Colombes, France

CANON (UK) LTD.

Woodhatch, Reigate, Surrey RH2 8BF, United Kingdom

CANON DEUTSCHLAND GmbH

Europark Fichtenhain A 10, 47807 Krefeld, Germany

CANON ITALIA S.p.A.

Palazzo L, Strada 6, 20089 Milanofiori-Rozzano (MI), Italy

CANON (Schweiz) A.G.

Industriestrasse 12, 8305 Dietlikon, Switzerland

CANON BENELUX N.V.

Neptunusstraat 1, 2132 JA Hoofddorp, The Netherlands

CANON BENELUX N.V./S.A.

Bessenveldstraat 7, 1831 Diegem (Machelen), Belgium

CANON GmbH

Zetschegasse 11, A-1232 Wien, Austria

CANON ESPANA S.A.

C/Joaquin Costa 41, 28002 Madrid, Spain

CANON SVENSKA AB

Stensättravägen 13, S-127 88 Skarholmen 2, Sweden

CANON NORGE A/S

Hallagerbakken 110, P. O. Box 2-33, Holmlia 1201 Oslo 12, Norway

CANON OY

Kornetintie 3, 00381 Helsinki, Finland

CANON HONGKONG CO., LTD.

9/F, The Hong Kong Club Building, 3A Chater Road, Central, Hong Kong

CANON SINGAPORE PTE. LTD.

79 Anson Road #09-01/06, Singapore 079906

CANON AUSTRALIA PTY. LTD.

1 Thomas Holt Drive, North Ryde, Sydney, N.S.W.2113, Australia

CANON NEW ZEALAND LTD.

Suite 4, 2nd Floor, Asda Plaza, Fred Thomas Drive, P.O.Box 33-336, Takapuna, Auckland, New Zealand